



**GENERATOR TYPE ECO 40-1S/4**

Document : **DS022A/1**  
issue 008 date 01/06/2011

<b>Electrical Characteristics</b>										
Frequency	Hz	50				60				
Voltage (series star)	V	380	400	415	440	415	440	460	480	
Rated power class H	kVA	400	400	400	370	420	450	480	480	
	kW	320	320	320	296	336	360	384	384	
Rated power class F	kVA	370	370	370	342	383	410	440	440	
	kW	296	296	296	274	306	328	352	352	
Regulation with	DSR	±1% with any power factor and speed variations between -5% +30%								
Insulation class		H								
Execution		Brushless								
Stator winding		12 ends								
Rotor		with damping cage								
Efficiencies class H	4/4	%	93,4	93,5	93,2	93	94,3	94,8	94,9	95
(see graph. for details)	3/4	%	93,5	93,8	93,7	93,4	94,6	94,8	94,9	95,2
	2/4	%	92,8	92,9	92,9	92,7	94,1	94,2	94,3	94,4
	1/4	%	89,2	89	88,8	88,7	90	90,1	90,1	90
Reactances (f. l.cl. F)	Xd	%	319,3	288,2	267,7	220,3	337,4	321,5	313,8	288
	Xd'	%	32,4	29,2	27,1	22,3	34,2	32,6	31,8	29,2
	Xd''	%	21,1	19,0	17,7	14,5	22,2	21,2	20,7	19,0
	Xq	%	144,9	130,8	121,5	100,0	153,1	145,9	142,4	130,8
	Xq'	%	144,9	130,8	121,5	100,0	153,1	145,9	142,4	130,8
	Xq''	%	39,2	35,4	32,9	27,1	41,4	39,5	38,5	35,4
	X <sub>2</sub>	%	30,1	27,2	25,3	20,8	31,8	30,3	29,6	27,2
	X <sub>0</sub>	%	4,18	3,77	3,50	2,88	4,41	4,21	4,10	3,77
Short Circuit Ratio	Kcc		0,30	0,36	0,55	0,90	0,24	0,27	0,30	0,36
Time Constants	Td'	sec.	0,11							
	Td''	sec.	0,014							
	Tdo'	sec.	2,50							
	Tα	sec.	0,013							
Short Circuit Current Capacity		%	>300				>350			
Excitation at no load	Amp.		0,7	0,8	0,9	1,1	0,5	0,6	0,7	0,8
Excitation at full load	Amp.		3,4	3,6	3,7	3,8	3,1	3,3	3,4	3,5
Overload (long-term)		%	1 hour in a 6 hours period 110% rated load							
Overload per 20 sec.		%	300							
Stator Winding Resistance (20°C)	Ω		0,0048							
Rotor Winding Resistance (20°C)	Ω		4,488							
Exciter Resistance (20 °C)	Ω		Rotor : 0,317				Stator : 8,85			
Heat dissipation at f.l.cl.H	W		22612	22246	23348	22280	20310	19747	20636	20211
Telephone Interference			THF < 2%				TIF < 40			
Radio interference			EN61000-6-3, EN61000-6-1. For others standards apply to factory							
Waveform Distors.(THD) at f. load	LL/LN %		2,6 / 2,6							
Waveform Distors.(THD) at no load	LL/LN %		2,9 / 2,9							
<b>Mechanical characteristics</b>										
Protection			IP 21 (other protection on request)							
DE bearing			6322							
NDE bearing			6318.2RS							
Weight of wound stator assembly	kg		327							
Weight of wound rotor assembly	kg		211							
Weight of complete generator	kg		1040							
Maximun overspeed	rpm		2250							
Unbalanced magnetic pull at f.l.cl.F	kN/mm		5							
Cooling air requirement	m³/min		54				64,8			
Inertia Constant (H)	sec.		0,176				0,212			
Noise level at 1m/7m	dB(A)		94 / 82				98 / 88			

All technical data are to be considered as a reference and they can be modified without any notice.

This document is a propriety of Mecc Alte S.p.A.. All rights reserved.

**50 Hz**

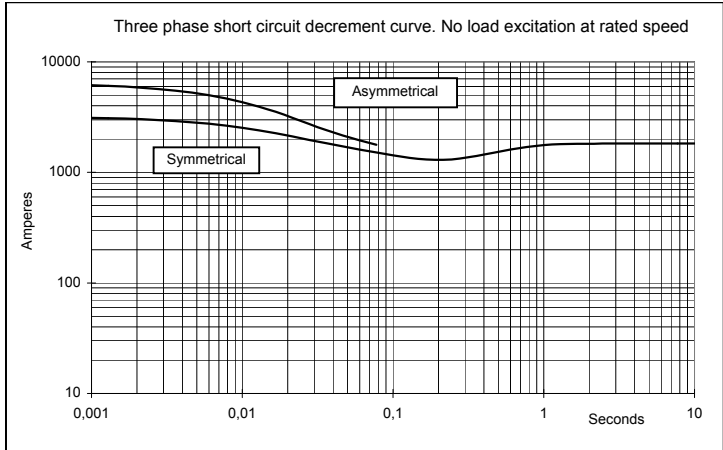
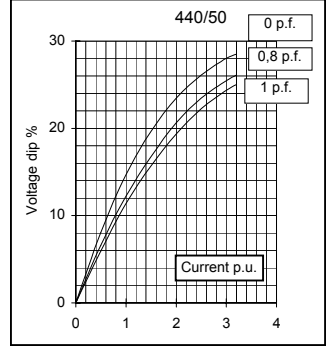
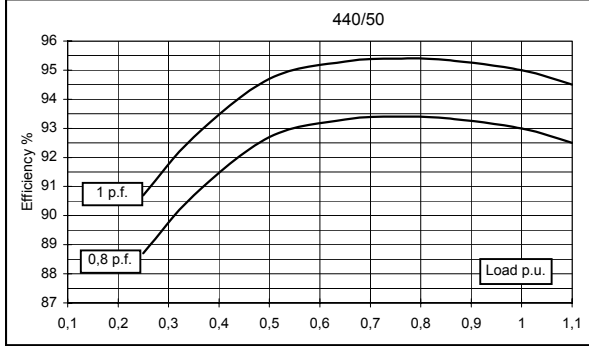
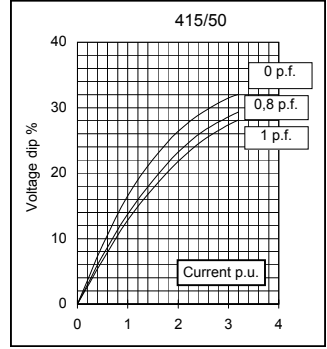
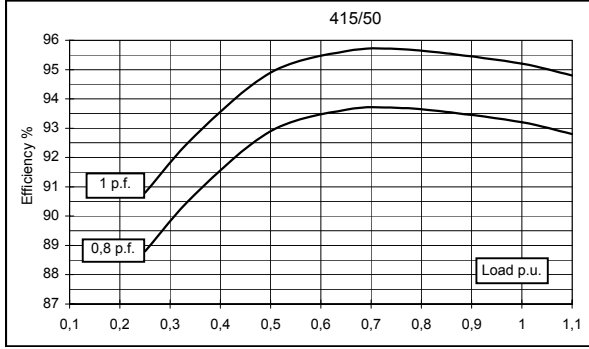
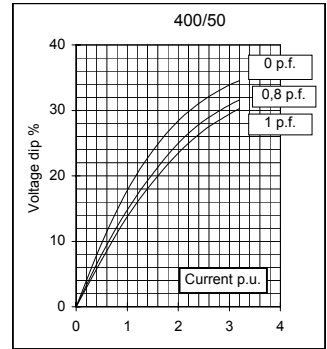
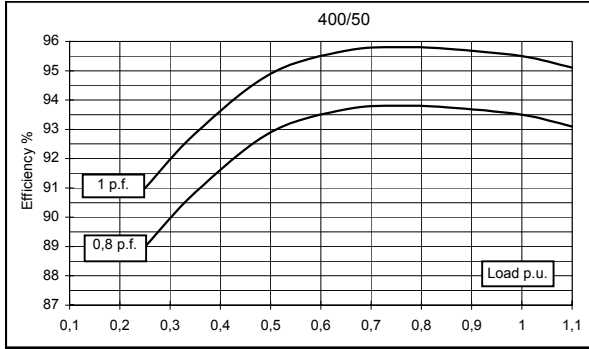
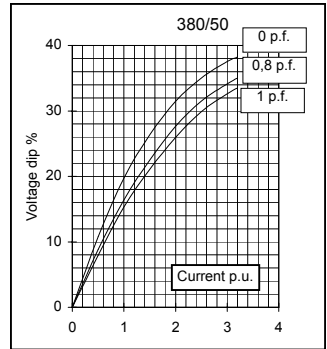
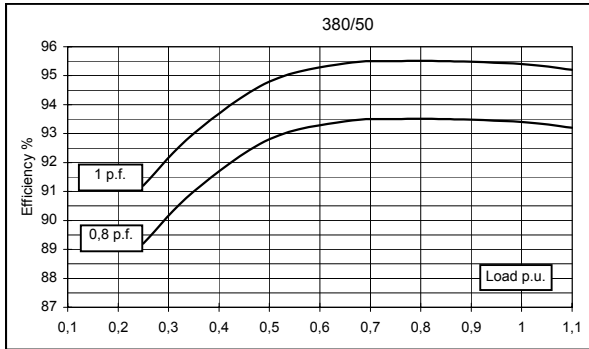

**60 Hz**

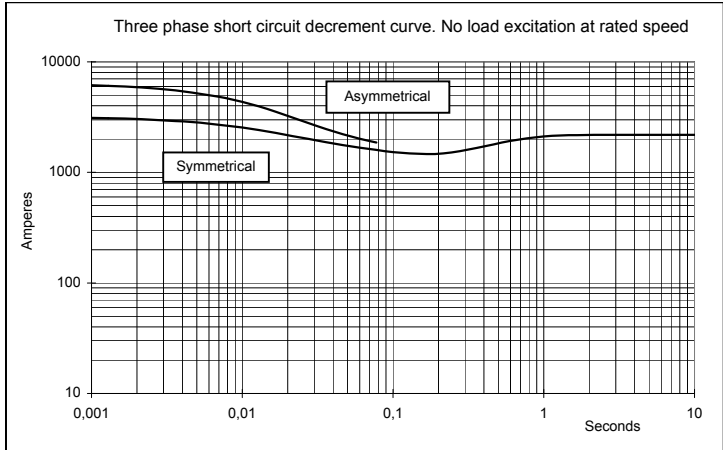
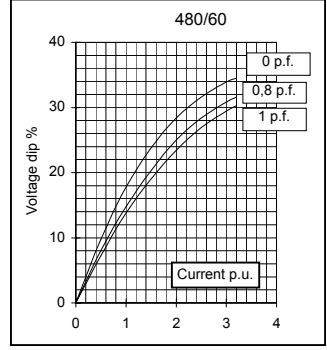
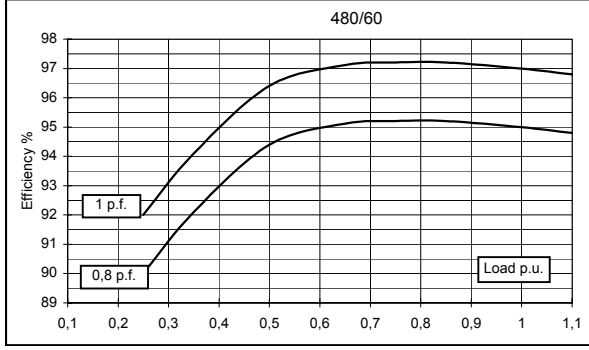
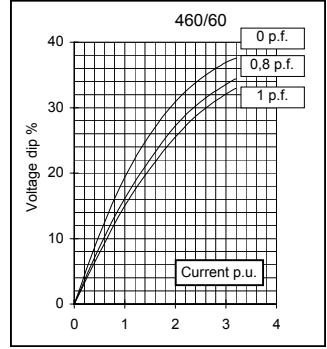
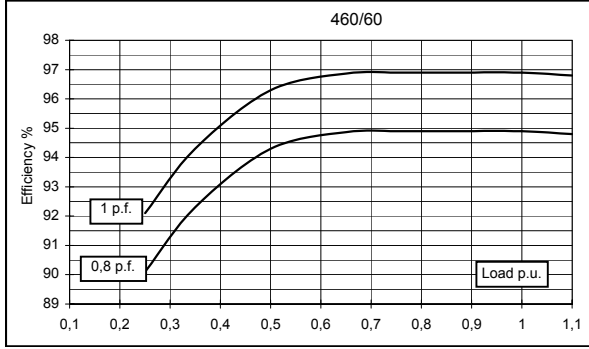
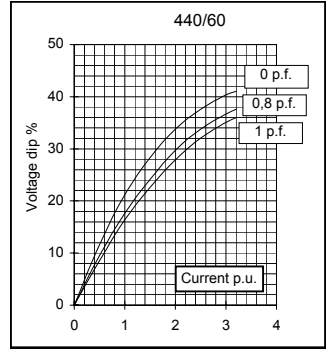
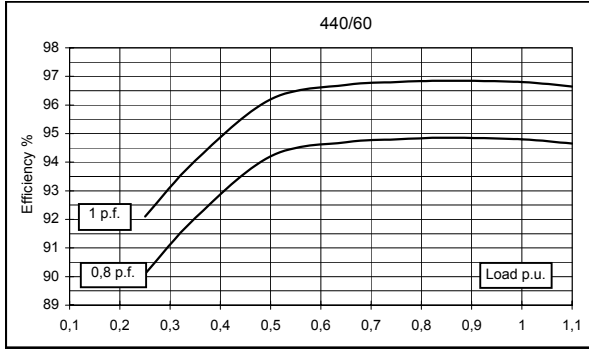
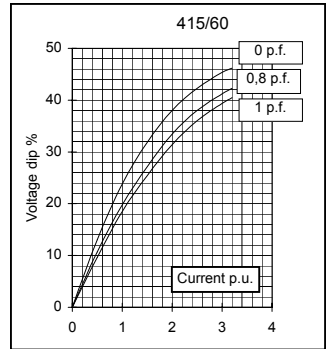
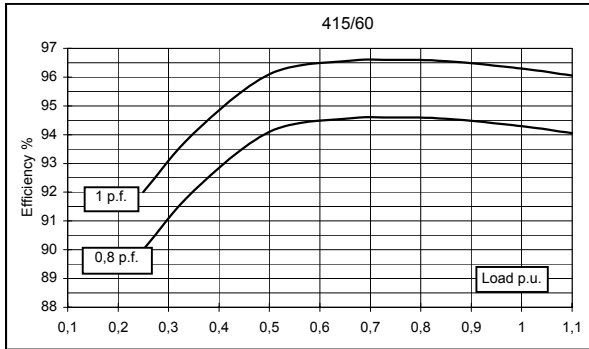



### SINGLE BEARING MOMENTS OF INERTIA

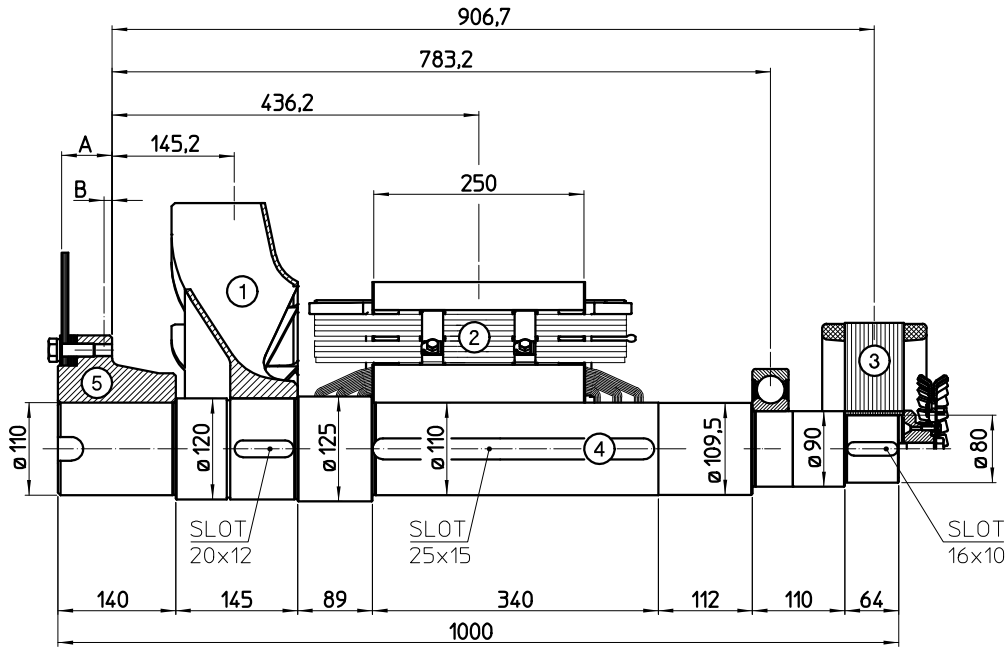

COMPONENT	WEIGHT kg	J kgm <sup>2</sup>
1 FAN	10,2	0,335
2 MAIN ROTOR	211	4,498
3 EX. ROTOR	35	0,562
4 SHAFT	72	0,111
TOTAL	328.2	5.506

Sae No	SHAFTS COUPLING FLEX PLATE			
	A	B	WEIGHT kg	J kgm <sup>2</sup>
14	60	9,6	41,4	0,511
18	50	6,6	45,1	0,858

### SINGLE BEARING DIMENSIONS

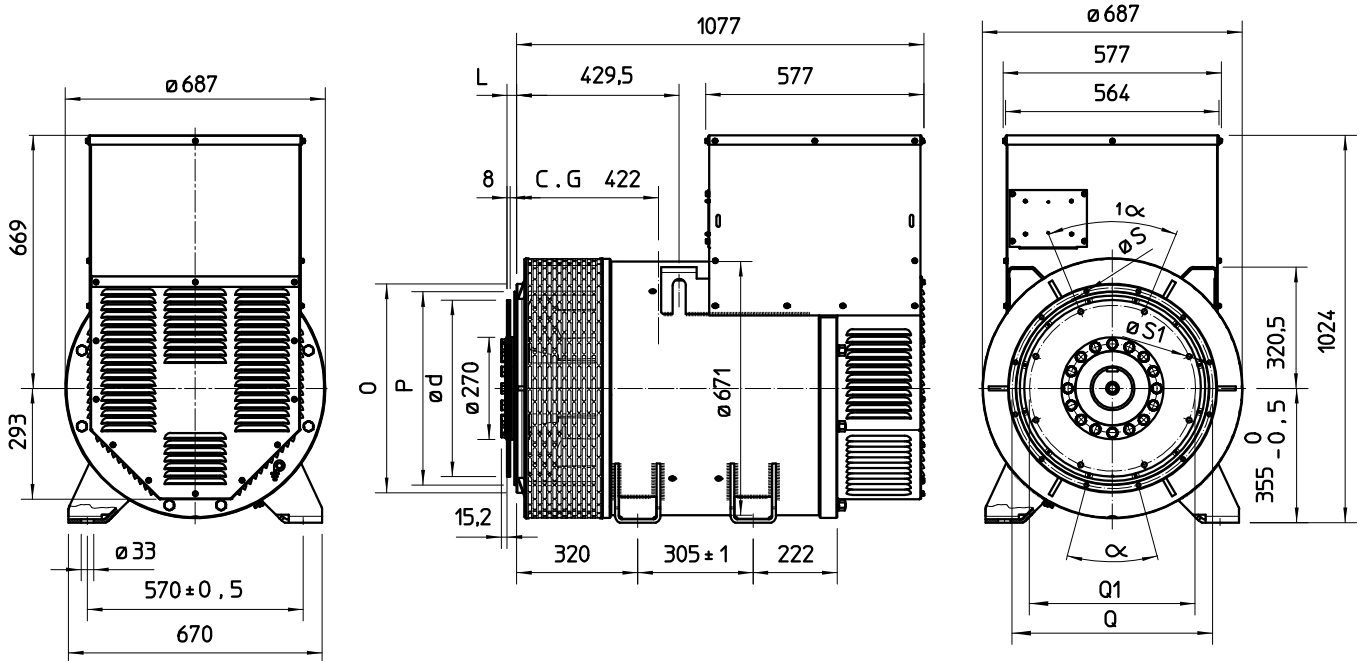

SAE N.	FLANGIA / FLANGE BRIDE / FLANSCH					
	O	P	Q	N. FORI	S	α
1	552	511,2	530,2	12	11	30°
1/2	648	584,2	619,1	12	14	30°
0	711	647,7	679,5	16	14	22,5°
00	883	787,4	850,9	16	14	22,5°

VOL. N.	GIUNTI A DISCHI / DISC COUPLING DISCQUE DE MONOPALIER / SCHEIBENKUPPLUNG					
	L	d	Q1	N. FORI	S1	α1
14	25,4	466,72	438,15	8	14	45°
18	15,7	571,5	542,92	6	17	60°

C.G.= GRAVITY CENTER