



GENERATOR TYPE ECO 40-1.5L/4

Document : **DS069A/1**
issue 004 date 01/06/2011

Electrical Characteristics										
Frequency	Hz	50				60				
Voltage (parallel star)	V	380	400	415	440	415	440	460	480	
Rated power class H	kVA	620	620	620	570	660	700	744	744	
	kW	496	496	496	456	528	560	595	595	
Rated power class F	kVA	560	560	560	515	600	632	672	672	
	kW	448	448	448	412	480	506	538	538	
Regulation with	DSR	±1% with any power factor and speed variations between -5% +30%								
Insulation class		H								
Execution		Brushless								
Stator winding		12 ends								
Rotor		with damping cage								
Efficiencies class H	4/4	%	94,2	94,3	94	93,8	95	95,5	95,6	95,7
(see graph. for details)	3/4	%	94,3	94,6	94,5	94,2	95,8	96	96,1	96,4
	2/4	%	93,6	93,7	93,7	93,5	95	95,1	95,2	95,3
	1/4	%	92,6	92,4	92,2	92,1	93,8	93,9	93,9	93,8
Reactances (f. l.cl. F)										
	Xd	%	300,3	271	251,8	205,9	321,6	303,4	295,1	271
	Xd'	%	29,4	26,5	24,6	20,1	31,4	29,7	28,9	26,5
	Xd''	%	18,2	16,4	15,2	12,5	19,5	18,4	17,9	16,4
	Xq	%	162,9	147	136,6	111,7	174,5	164,6	160,1	147
	Xq'	%	162,9	147	136,6	111,7	174,5	164,6	160,1	147
	Xq''	%	22,5	20,3	18,9	15,4	24,1	22,7	22,1	20,3
	X ₂	%	20,5	18,5	17,2	14,1	22,0	20,7	20,1	18,5
	X ₀	%	3,2	2,9	2,7	2,2	3,4	3,2	3,2	2,9
Short Circuit Ratio	Kcc		0,35	0,40	0,75	1,30	0,23	0,27	0,35	0,40
Time Constants	Td'	sec.	0,132							
	Td''	sec.	0,0164							
	Tdo'	sec.	2,89							
	Tα	sec.	0,037							
Short Circuit Current Capacity		%	>300				>350			
Excitation at no load	Amp.		0,65	0,74	0,8	0,95	0,47	0,54	0,6	0,65
Excitation at full load	Amp.		3	3,1	3,5	3,6	2,3	2,5	2,8	3
Overload (long-term)		%	1 hour in a 6 hours period 110% rated load							
Overload per 20 sec.		%	300							
Stator Winding Resistance (20°C)	Ω		0,0087							
Rotor Winding Resistance (20°C)	Ω		1,376							
Exciter Resistance (20 °C)	Ω		Rotor : 0,050				Stator : 8,85			
Heat dissipation at f.l.cl.H	W		30539	29981	31660	30141	27789	26387	27394	26744
Telephone Interference			THF < 2%				TIF < 40			
Radio interference			EN61000-6-3, EN61000-6-1. For others standards apply to factory							
Waveform Distors.(THD) at f. load	LL/LN %		2,2 / 2,4							
Waveform Distors.(THD) at no load	LL/LN %		2,4 / 2,5							
Mechanical characteristics										
Protection			IP 21 (other protection on request)							
DE bearing			6322							
NDE bearing			6318.2RS							
Weight of wound stator assembly	kg		524							
Weight of wound rotor assembly	kg		369							
Weight of complete generator	kg		1380							
Maximun overspeed	rpm		2250							
Unbalanced magnetic pull at f.l.cl.F	kN/mm		6,1							
Cooling air requirement	m ³ /min		54				64,8			
Inertia Constant (H)	sec.		0,179				0,214			
Noise level at 1m/7m	dB(A)		94 / 82				98 / 88			

All technical data are to be considered as a reference and they can be modified without any notice.

This document is a propriety of Mecc Alte S.p.A.. All rights reserved.



GENERATOR TYPE ECO 40-1.5L/4

Document : DS069A/2
issue 001 date : 01/06/2011

50 Hz

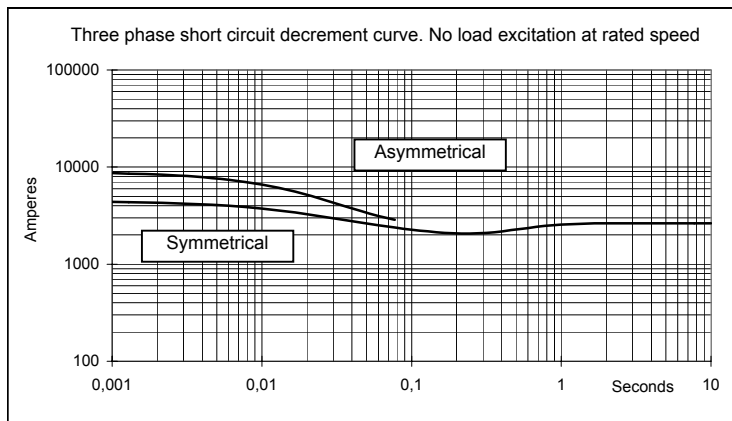
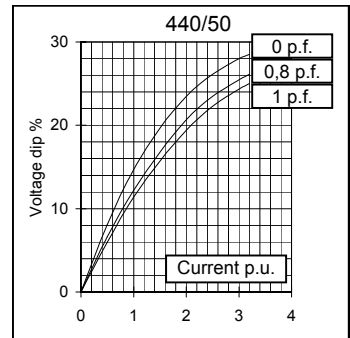
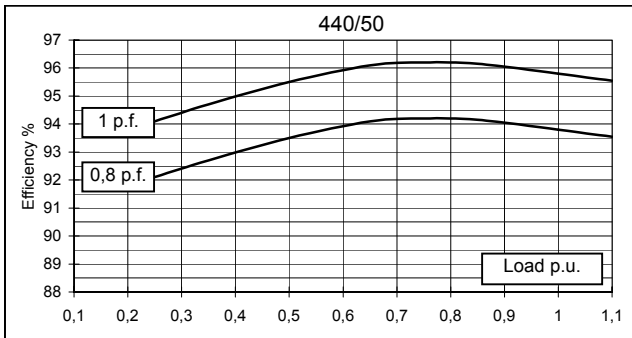
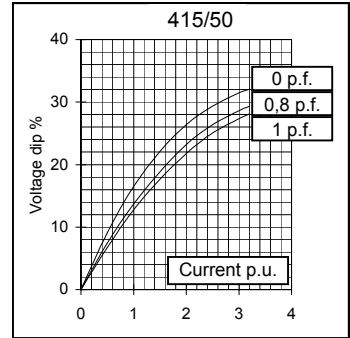
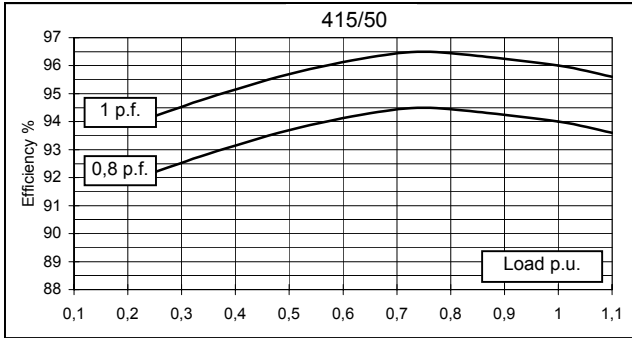
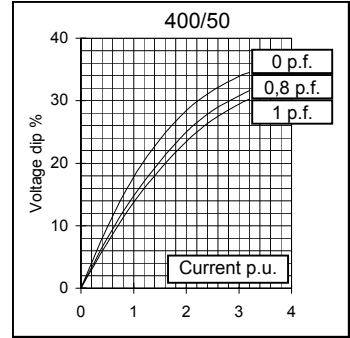
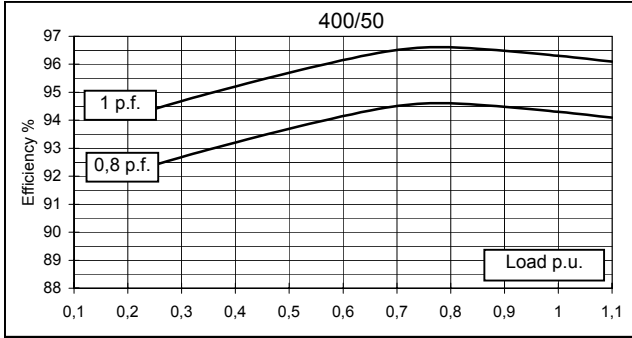
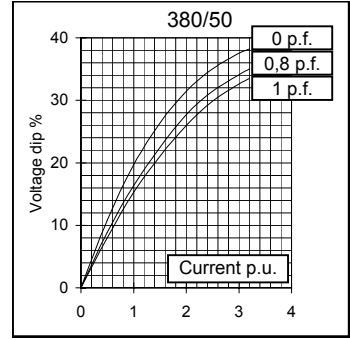
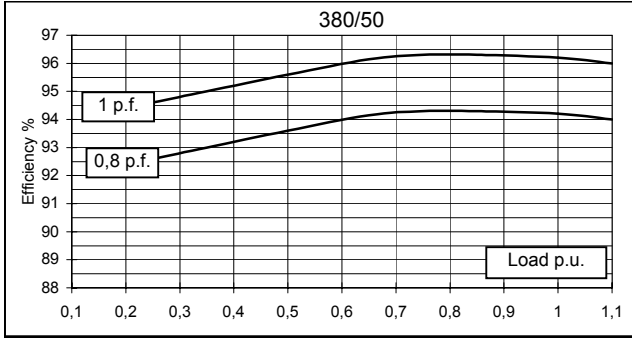



GENERATOR TYPE ECO 40-1.5L/4

Document : DS069A/3
 issue 001 date : 01/06/2011

60 Hz

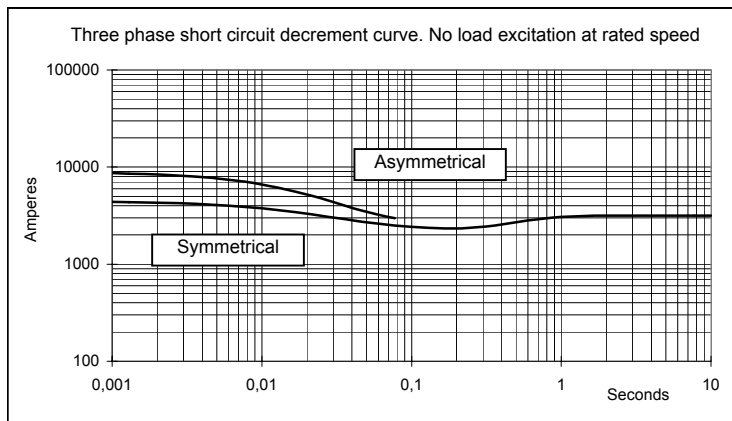
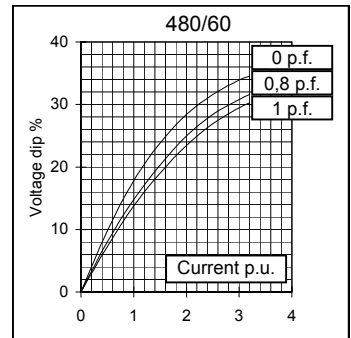
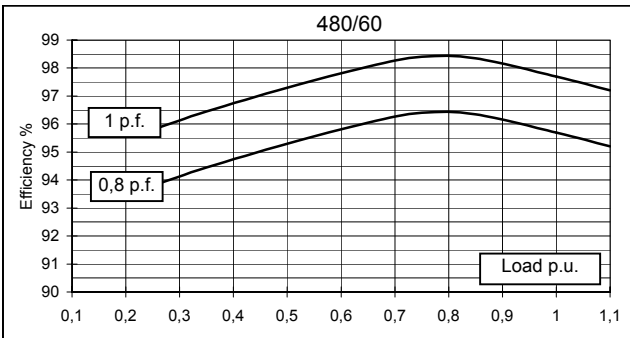
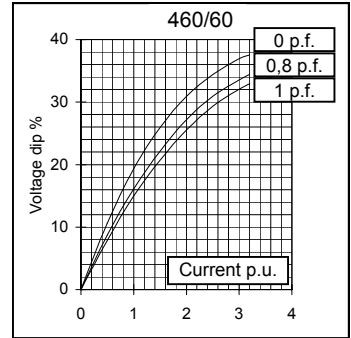
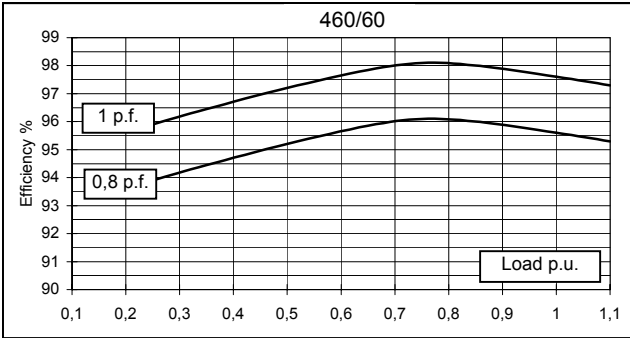
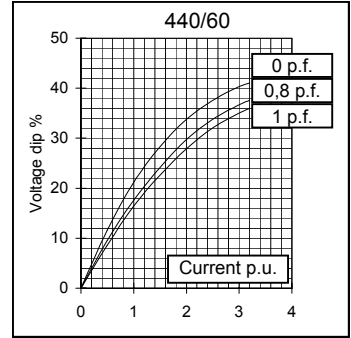
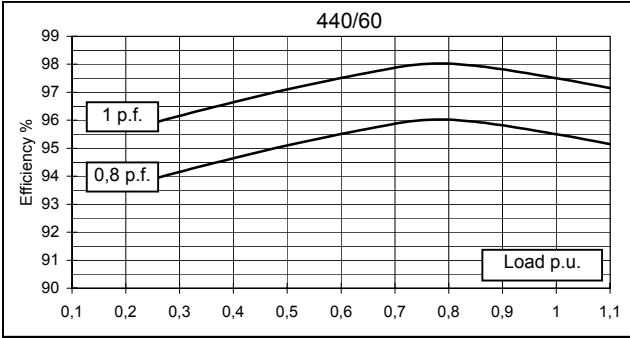
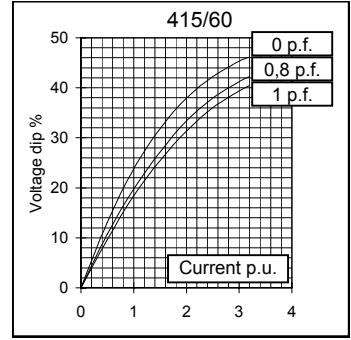
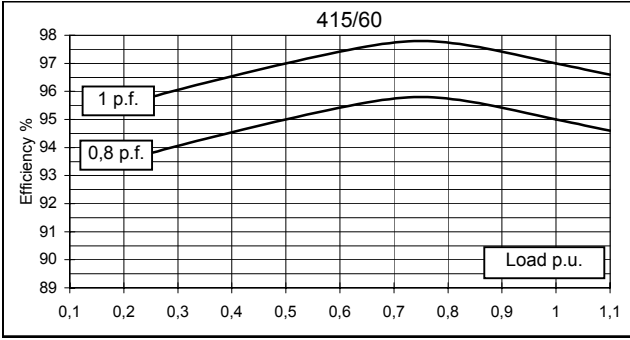

TWO BEARING MOMENTS OF INERTIA

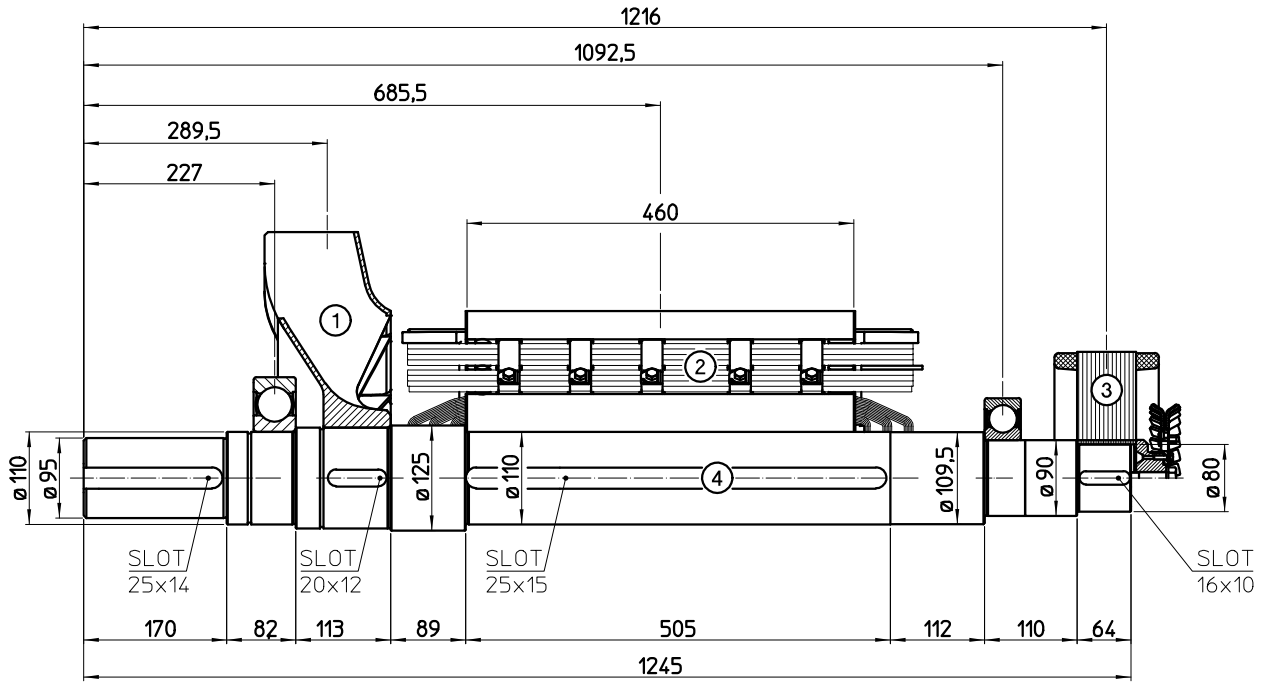

COMPONENT	WEIGHT kg	J kgm ²
1 FAN	10,2	0,335
2 MAIN ROTOR	369	7,715
3 EX. ROTOR	35	0,562
4 SHAFT	85,7	0,127
TOTAL	499,9	8,739

TWO BEARING DIMENSIONS

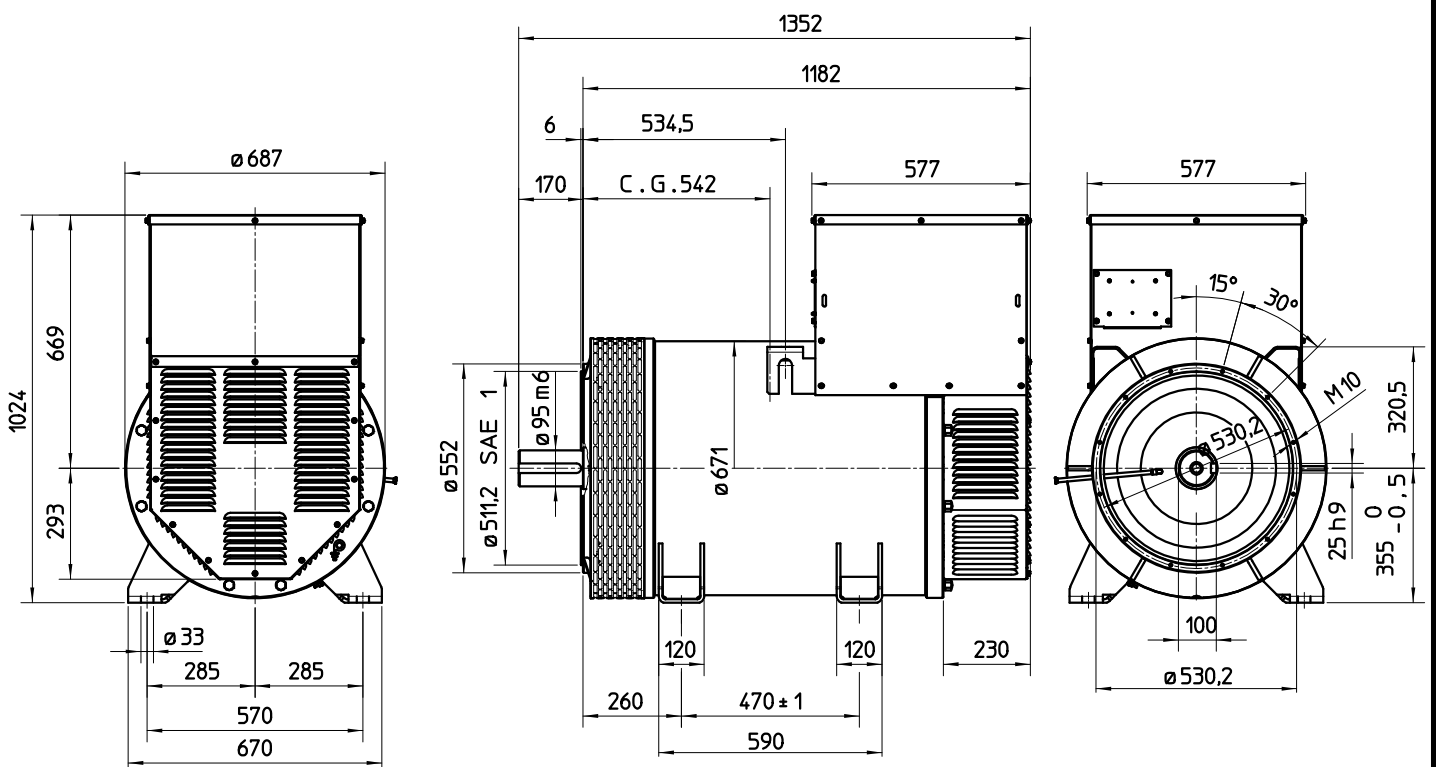

C.G.= GRAVITY CENTER

SINGLE BEARING MOMENTS OF INERTIA

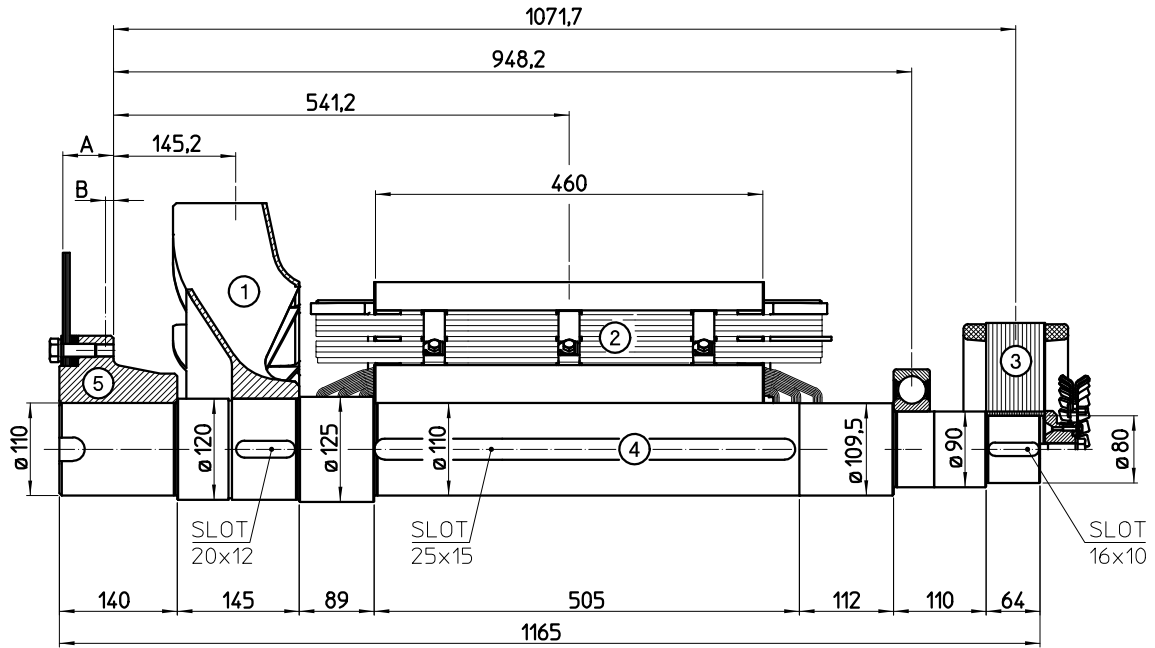

COMPONENT	WEIGHT kg	J kgm ²
1 FAN	10,2	0,335
2 MAIN ROTOR	369	7,715
3 EX. ROTOR	35	0,562
4 SHAFT	84,2	0,129
TOTAL	498,4	8,741

Sae No	SHAFTS COUPLING FLEX PLATE			
	A	B	WEIGHT kg	J kgm ²
14	60	9,6	41,4	0,511
18	50	6,6	45,1	0,858

SINGLE BEARING DIMENSIONS

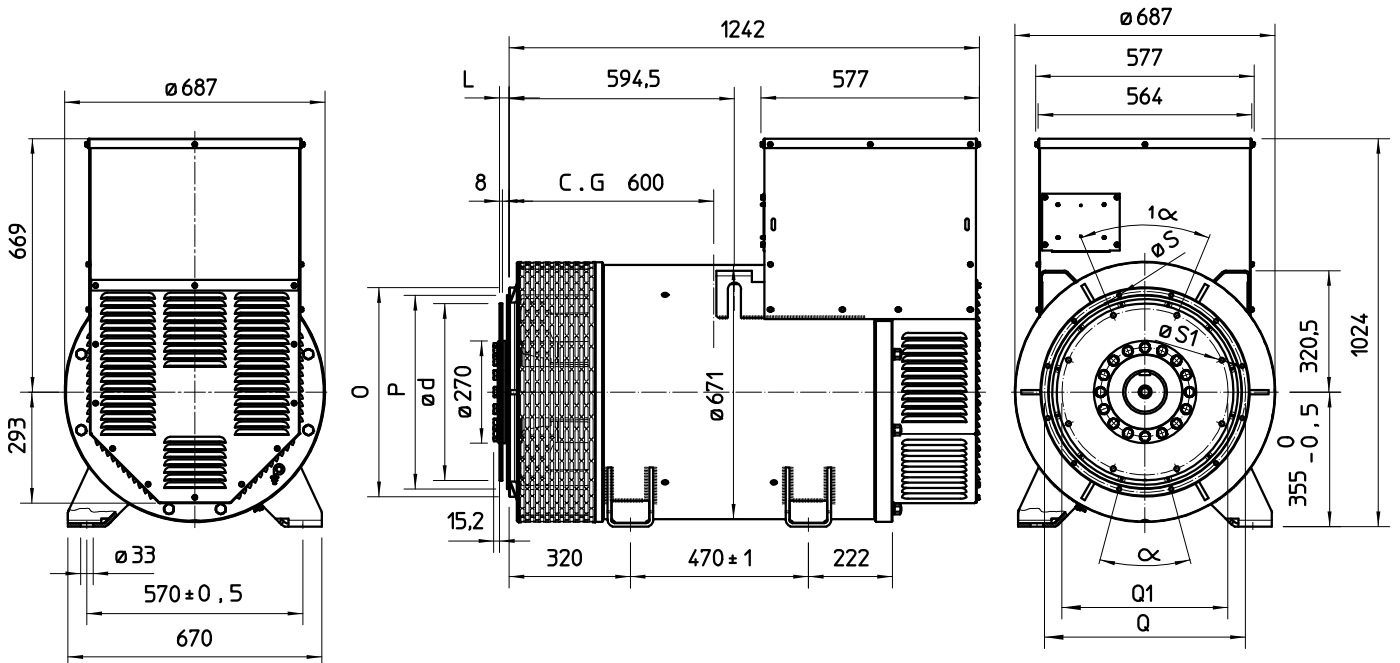

SAE N.	FLANGIA / FLANGE BRIDE / FLANSCH					
	O	P	Q	N. FORI	S	α
1	552	511,2	530,2	12	11	30°
1/2	648	584,2	619,1	12	14	30°
0	711	647,7	679,5	16	14	22,5°
00	883	787,4	850,9	16	14	22,5°

VOL. N.	GIUNTI A DISCHI / DISC COUPLING DISCQUE DE MONOPALIER / SCHEIBENKUPPLUNG					
	L	d	Q1	N. FORI	S1	α1
14	25,4	466,72	438,15	8	14	45°
18	15,7	571,5	542,92	6	17	60°

C.G.= GRAVITY CENTER