



GENERATOR TYPE ECO 38-3LN/4

Document : DS075A/1

issue 003 date 01/06/2011

Electrical Characteristics										
Frequency	Hz	50				60				
Voltage (series star)	V	380	400	415	440	415	440	460	480	
Rated power class H	kVA	350	350	350	340	380	420	420	420	
	kW	280	280	280	272	304	336	336	336	
Rated power class F	kVA	320	320	320	310	350	385	385	385	
	kW	256	256	256	248	280	308	308	308	
Regulation with DSR		±1 % with any power factor and speed variations between -5% +30%								
Insulation class		H								
Execution		Brushless								
Stator winding		12 ends								
Rotor		with damping cage								
Efficiencies class H	4/4	%	93,4	93,5	93,2	93	93,6	94,1	94,2	94,3
(see graph. for details)	3/4	%	93,4	93,7	93,6	93,3	93,9	94,1	94,3	94,5
	2/4	%	92,5	92,6	92,6	92,4	93	93,1	93,2	93,3
	1/4	%	90,1	89,9	89,7	89,5	90,6	90,6	90,6	90,4
Reactances (f. l.cl. F)										
	Xd	%	238,2	215	199,7	172,6	260,2	255,9	234,1	215
	Xd'	%	19,1	17,2	16,0	13,8	20,8	20,5	18,7	17,2
	Xd''	%	10,4	9,4	8,7	7,5	11,4	11,2	10,2	9,4
	Xq	%	139,6	126	117,1	101,2	152,5	150,0	137,2	126
	Xq'	%	139,6	126	117,1	101,2	152,5	150,0	137,2	126
	Xq''	%	22,3	20,1	18,7	16,1	24,3	23,9	21,9	20,1
	X ₂	%	17,4	15,7	14,6	12,6	19,0	18,7	17,1	15,7
	X ₀	%	2,4	2,2	2,0	1,8	2,7	2,6	2,4	2,2
Short Circuit Ratio	Kcc		0,37	0,42	0,57	0,92	0,24	0,32	0,37	0,42
Time Constants										
	Td'	sec.	0,099							
	Td''	sec.	0,0127							
	Tdo'	sec.	1,50							
	Tα	sec.	0,013							
Short Circuit Current Capacity										
Excitation at no load	Amp.		>300				>350			
Excitation at full load	Amp.		0,55	0,72	0,95	1,2	0,35	0,35	0,6	0,7
Overload (long-term)	%	1 hour in a 6 hours period 110% rated load								
Overload per 20 sec.	%	300								
Stator Winding Resistance (20°C)	Ω	0,0042								
Rotor Winding Resistance (20°C)	Ω	6,780								
Exciter Resistance (20 °C)	Ω	Rotor : 0,685				Stator : 15,28				
Heat dissipation at f.l.cl.H	W	19786	19465	20429	20473	20786	21067	20688	20310	
Telephone Interference		THF < 2%				TIF < 40				
Radio interference		EN61000-6-3, EN61000-6-1. For others standards apply to factory								
Waveform Distors.(THD) at f. load	LL/LN %	3,1 / 2,9								
Waveform Distors.(THD) at no load	LL/LN %	2,7 / 2,7								
Mechanical characteristics										
Protection		IP 21 (other protection on request)								
DE bearing		6318.2RS								
NDE bearing		6314.2RS								
Weight of wound stator assembly	kg	347								
Weight of wound rotor assembly	kg	230								
Weight of complete generator	kg	905								
Maximun overspeed	rpm	2250								
Unbalanced magnetic pull at f.l.cl.F	kN/mm	6,2								
Cooling air requirement	m ³ /min	32				39				
Inertia Constant (H)	sec.	0,123				0,147				
Noise level at 1m/7m	dB(A)	82 / 69				86 / 73				

All technical data are to be considered as a reference and they can be modified without any notice.

This document is a propriety of Mecc Alte S.p.a..All rights reserved.



GENERATOR TYPE ECO 38-3LN/4

Document : DS075A/2

issue 003 date : 01/06/2011

50 Hz

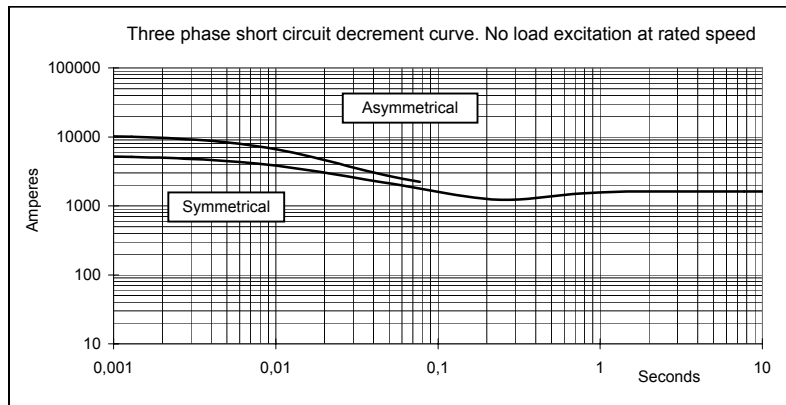
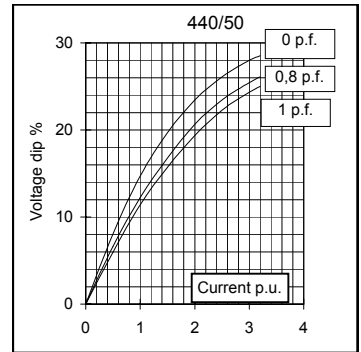
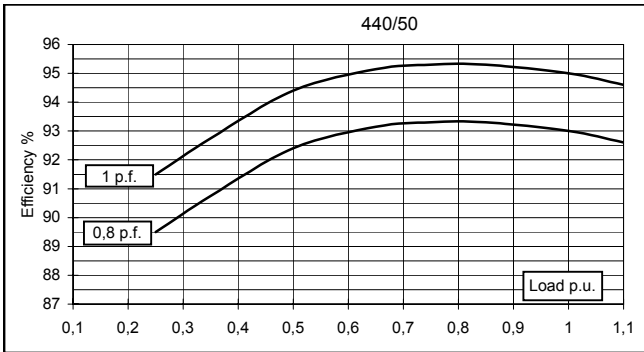
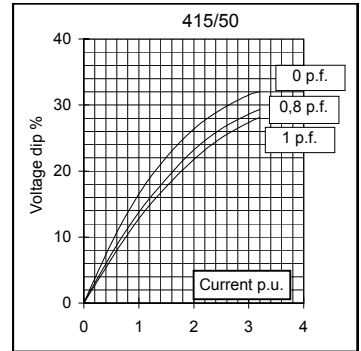
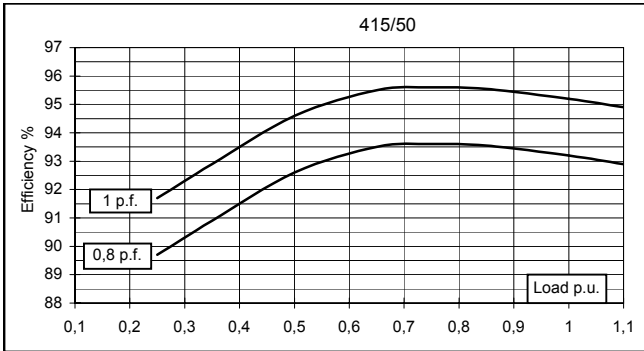
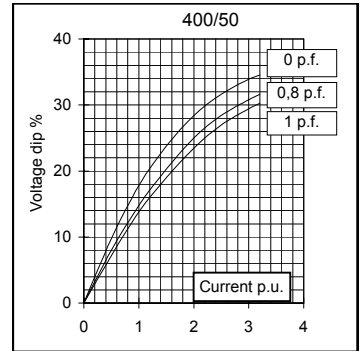
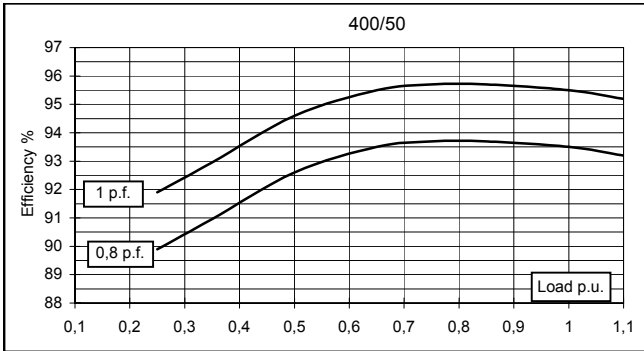
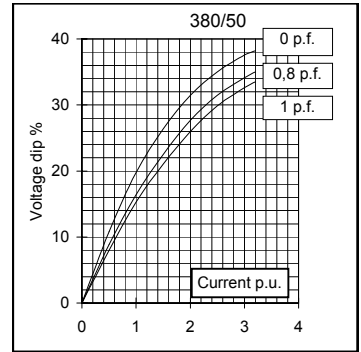
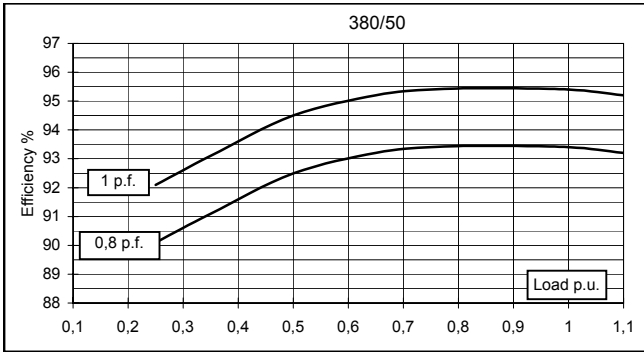



GENERATOR TYPE ECO 38-3LN/4

Document : DS075A/3

issue 003 date : 01/06/2011

60 Hz

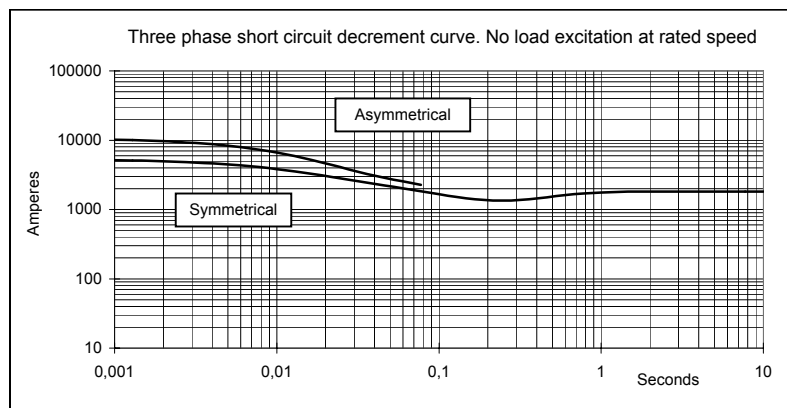
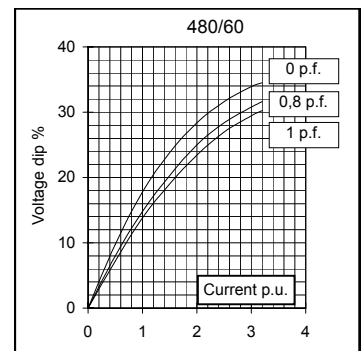
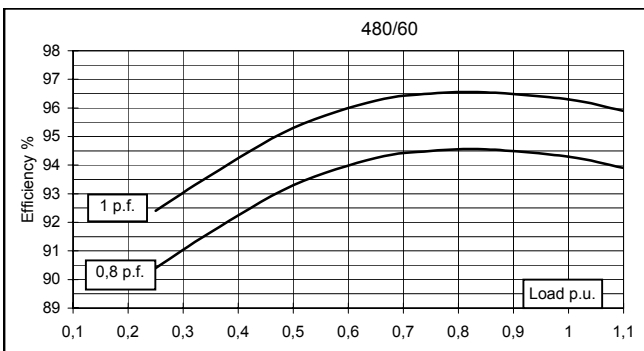
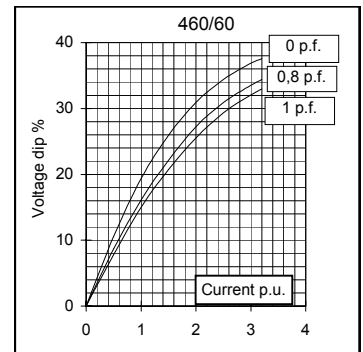
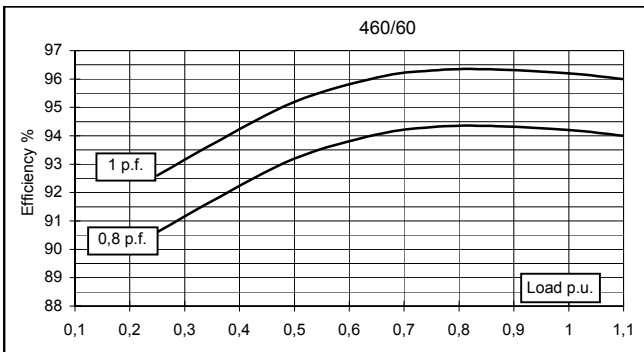
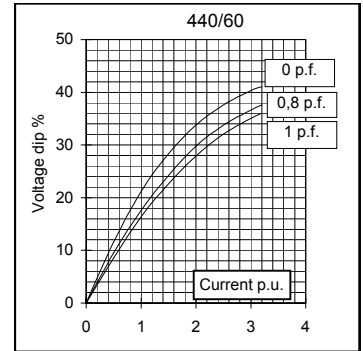
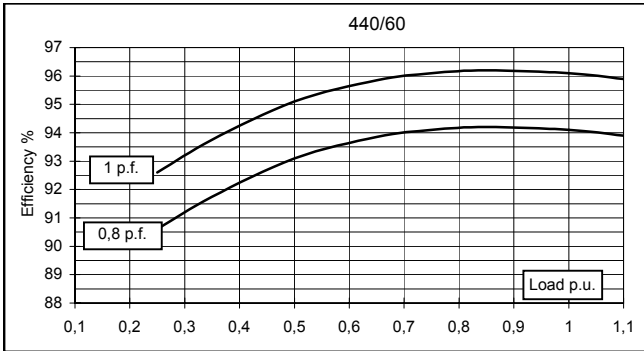
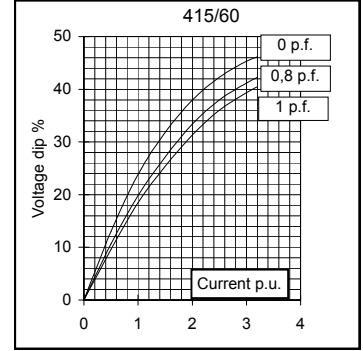
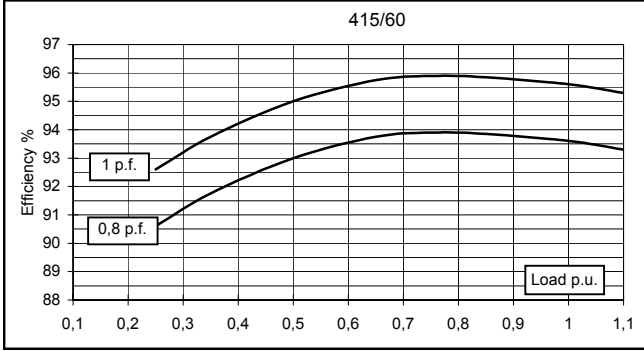

TWO BEARING MOMENTS OF INERTIA

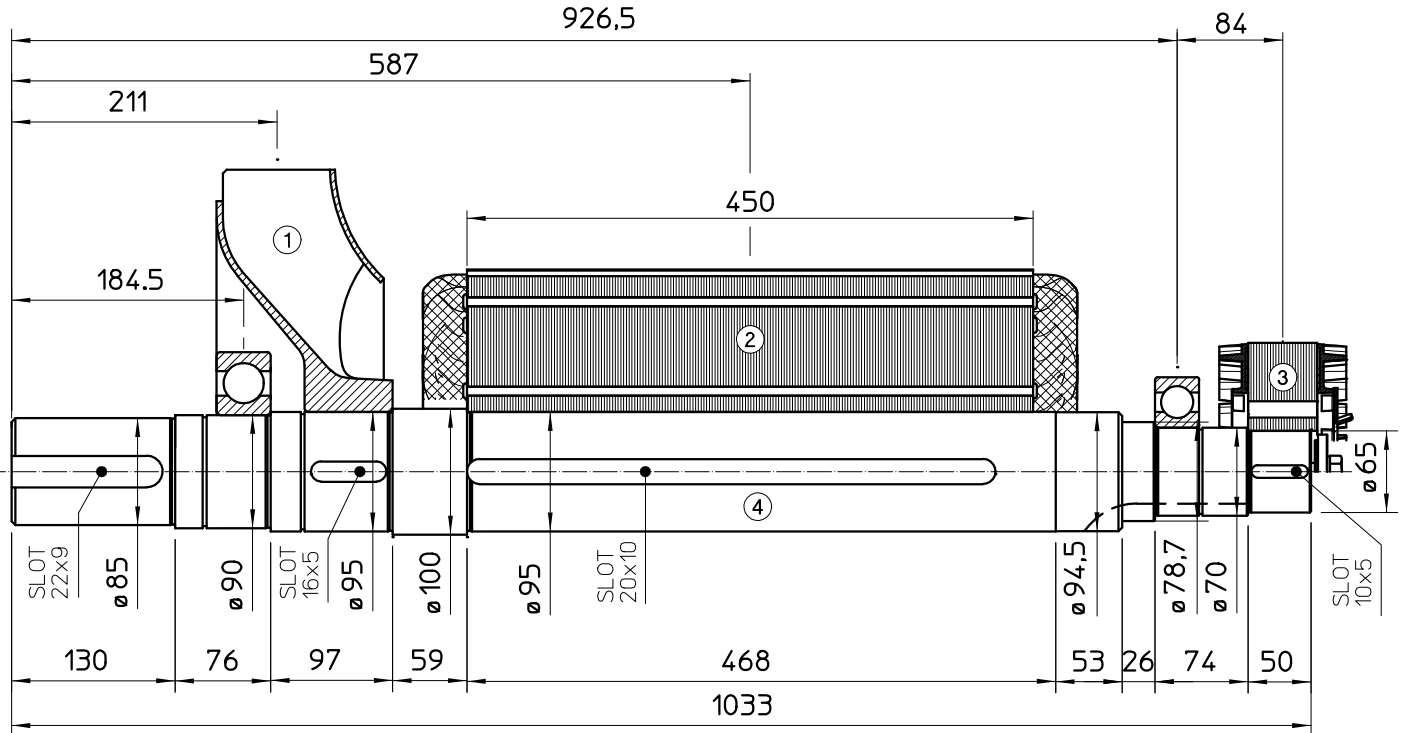

POS.	COMPONENT	WEIGHT (kg)	J (kgm ²)
1	FAN	6.1	0.1887
2	MAIN ROTOR	230	3.1461
3	EX. ROTOR	14.5	0.0874
4	SHAFT	49.9	0.0525
TOTAL		300.5	3.4747

TWO BEARING DIMENSIONS

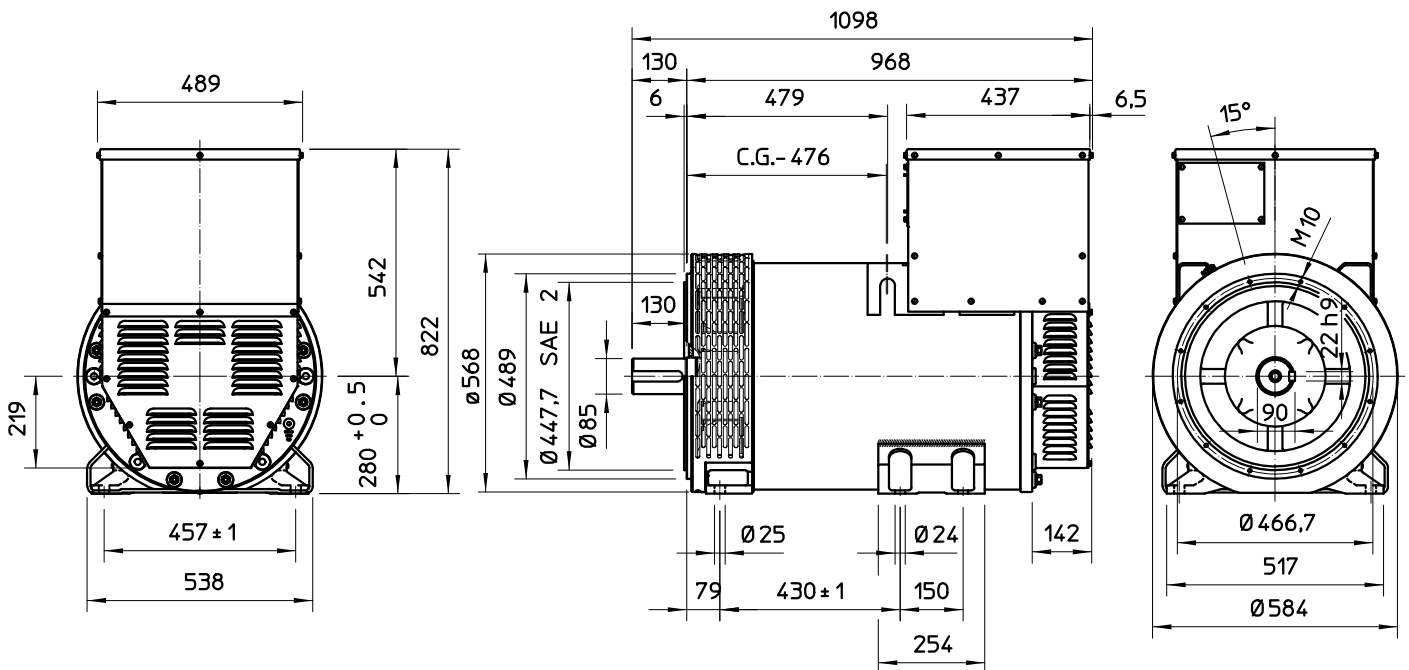

C.G.= GRAVITY CENTER

SINGLE BEARING MOMENTS OF INERTIA

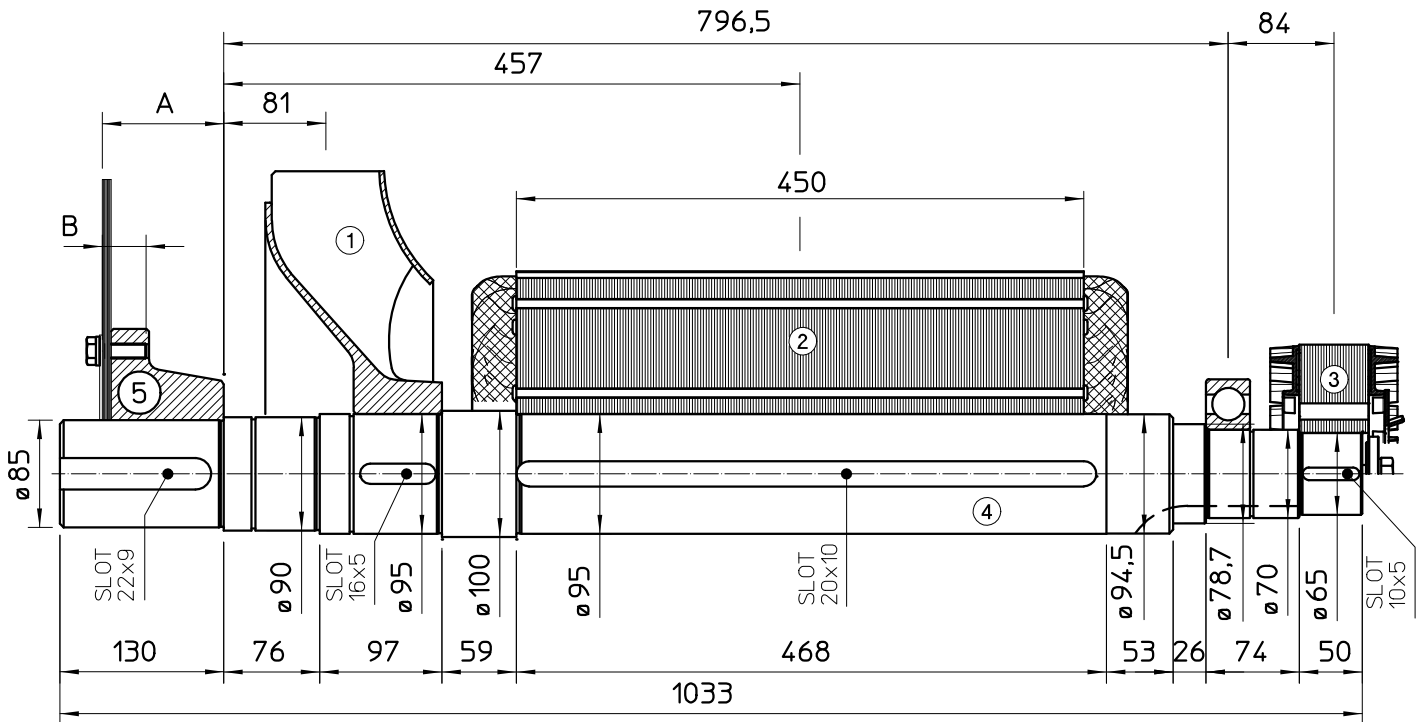

POS.	COMPONENT	WEIGHT (kg)	J (kgm ²)
1	FAN	6.1	0.1887
2	MAIN ROTOR	230	3.1461
3	EX. ROTOR	14.5	0.0874
4	SHAFT	49.9	0.0525
TOTAL		300.5	3.4747

SAE N°	SHAFTS COUPLING FLEX PLATE			
	A	B	WEIGHT kg	J kgm ²
11.5	110.4	41.1	20.5	0.174
14	96.4	34.7	23.5	0.275

SINGLE BEARING DIMENSIONS

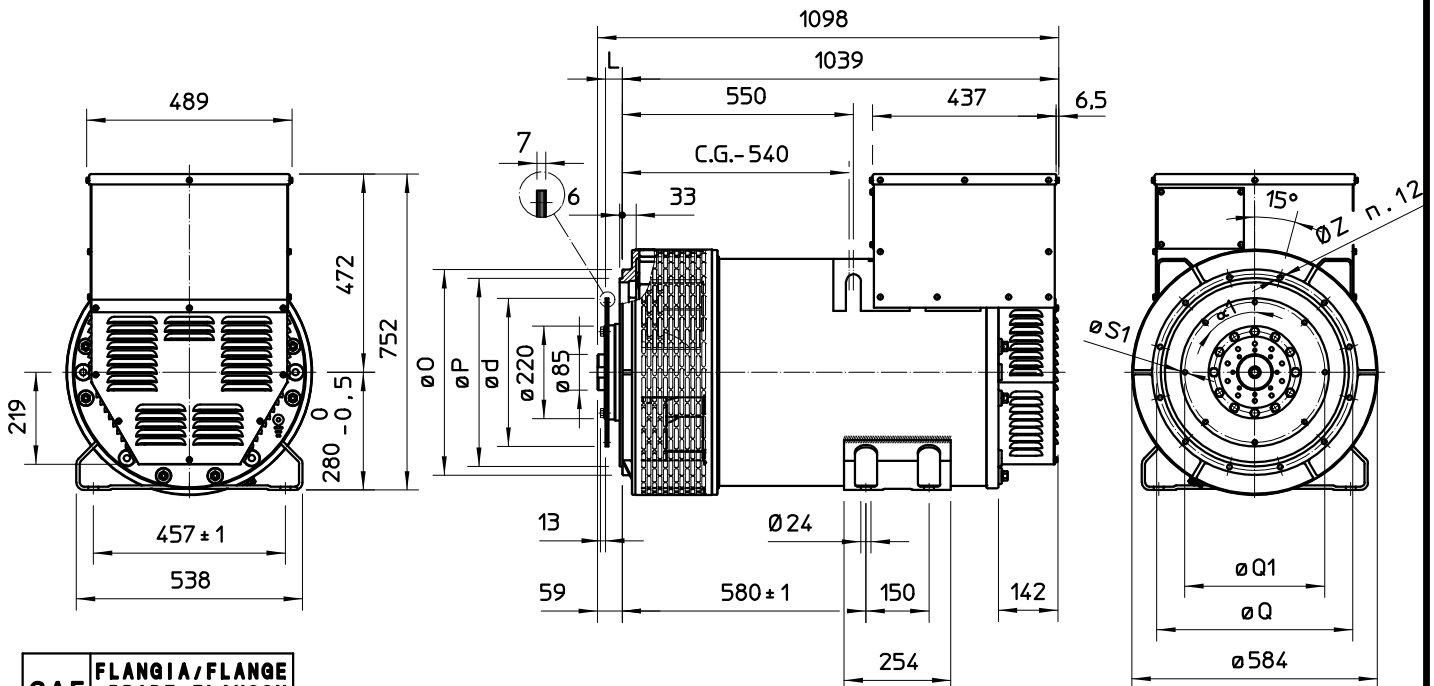

SAE N.	FLANGIA/FLANGE BRIDE/FLANSCH		
	O	P	Q
3	451	409,6	428,6
2	489	447,7	466,7
1	552	511,2	530,2
1/2	648	584,2	619,1

SAE N.	GIUNTI A DISCHI DISC COUPLING DISQUE DE MONOPALIER SCHEIBENKUPPLUNG					
	L	d	Q1	n _{fori}	S1	$\alpha 1$
11 1/2	39,6	352,42	333,37	8	11	45°
14	25,4	466,72	438,15	8	14	45°

C.G.= GRAVITY CENTER