



GENERATOR TYPE ECO 38-1SN/4

Document : DS070A/1

issue 003 date 01/06/2011

Electrical Characteristics										
Frequency	Hz	50				60				
Voltage (series star)	V	380	400	415	440	415	440	460	480	
Rated power class H	kVA	180	180	180	165	210	220	220	220	
	kW	144	144	144	132	168	176	176	176	
Rated power class F	kVA	170	170	170	155	195	205	205	205	
	kW	136	136	136	124	156	164	164	164	
Regulation with DSR		±1 % with any power factor and speed variations between -5% +30%								
Insulation class		H								
Execution		Brushless								
Stator winding		12 ends								
Rotor		with damping cage								
Efficiencies class H	4/4	%	92,3	92,4	92,1	91,9	92,7	93,2	93,3	93,4
(see graph. for details)	3/4	%	92,3	92,6	92,5	92,2	93	93,2	93,4	93,6
	2/4	%	91,2	91,3	91,3	91,1	92	92,1	92,2	92,3
	1/4	%	89,1	88,9	88,7	88,5	90,1	90,1	90,1	89,9
Reactances (f. l.cl. F)	Xd	%	218,3	197	183,0	149,2	251,6	234,4	214,5	197
	Xd'	%	10,7	9,7	9,0	7,3	12,4	11,5	10,6	9,7
	Xd''	%	6,1	5,5	5,1	4,2	7,0	6,5	6,0	5,5
	Xq	%	107,4	96,9	90,0	73,4	123,7	115,3	105,5	96,9
	Xq'	%	107,4	96,9	90,0	73,4	123,7	115,3	105,5	96,9
	Xq''	%	21,8	19,7	18,3	14,9	25,2	23,4	21,5	19,7
	X ₂	%	14,2	12,8	11,9	9,7	16,3	15,2	13,9	12,8
	X ₀	%	3,0	2,7	2,5	2,0	3,4	3,2	2,9	2,7
Short Circuit Ratio	Kcc		0,39	0,44	0,60	0,97	0,28	0,35	0,39	0,44
Time Constants	Td'	sec.	0,073							
	Td''	sec.	0,011							
	Tdo'	sec.	0,70							
	Tα	sec.	0,015							
Short Circuit Current Capacity		%	>300				>350			
Excitation at no load	Amp.		0,65	0,7	0,8	1,1	0,35	0,5	0,6	0,65
Excitation at full load	Amp.		2,9	3,1	3,4	3,5	2,5	2,7	2,8	3
Overload (long-term)		%	1 hour in a 6 hours period 110% rated load							
Overload per 20 sec.		%	300							
Stator Winding Resistance (20°C)		Ω	0,013							
Rotor Winding Resistance (20°C)		Ω	3,905							
Exciter Resistance (20 °C)		Ω	Rotor : 0,685				Stator : 15,28			
Heat dissipation at f.l.cl.H	W		12013	11844	12352	11634	13230	12841	12639	12437
Telephone Interference			THF < 2%				TIF < 40			
Radio interference			EN61000-6-3, EN61000-6-1. For others standards apply to factory							
Waveform Distors.(THD) at f. load	LL/LN %		2,8 / 2,7							
Waveform Distors.(THD) at no load	LL/LN %		3,1 / 3							
Mechanical characteristics										
Protection			IP 21 (other protection on request)							
DE bearing			6318.2RS							
NDE bearing			6314.2RS							
Weight of wound stator assembly	kg		168							
Weight of wound rotor assembly	kg		103							
Weight of complete generator	kg		510							
Maximun overspeed	rpm		2250							
Unbalanced magnetic pull at f.l.cl.F	kN/mm		4,4							
Cooling air requirement	m ³ /min		32				39			
Inertia Constant (H)	sec.		0,118				0,140			
Noise level at 1m/7m	dB(A)		82 / 69				86 / 73			

All technical data are to be considered as a reference and they can be modified without any notice

This document is a propriety of Mecc Alte S.p.a..All rights reserved.

50 Hz

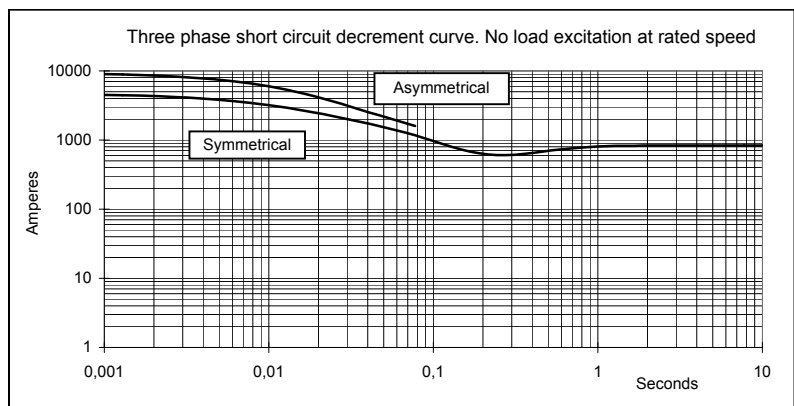
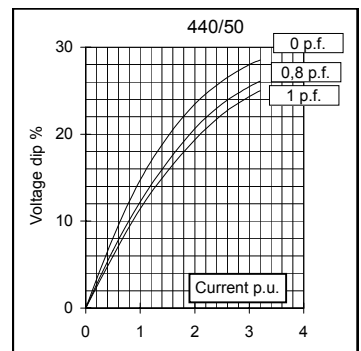
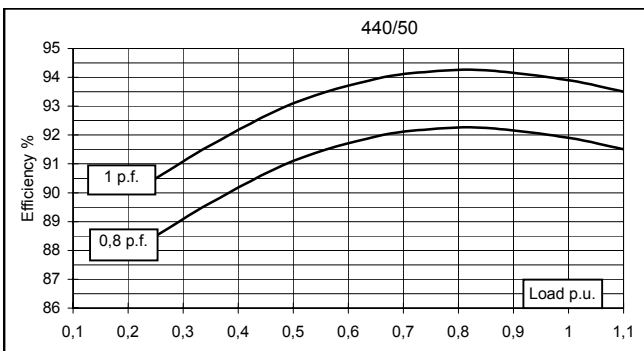
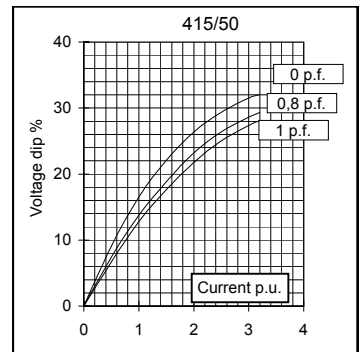
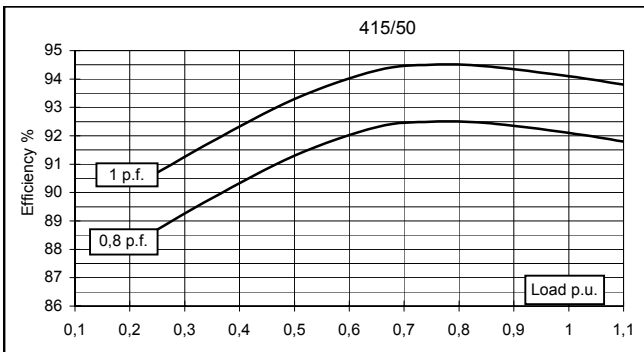
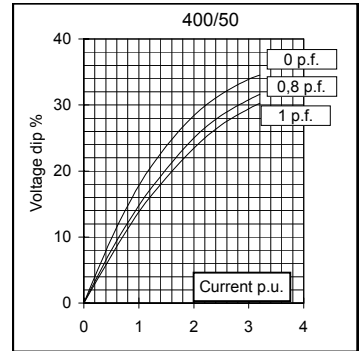
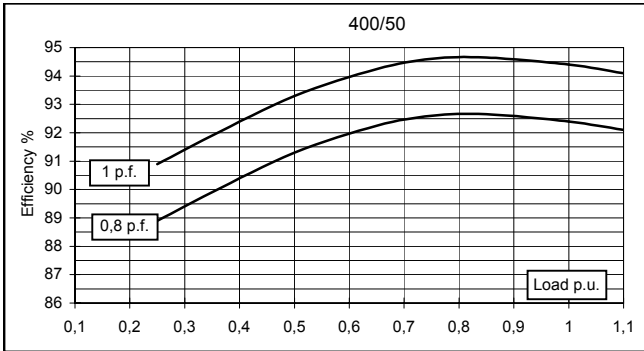
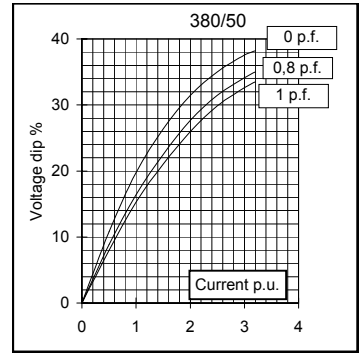
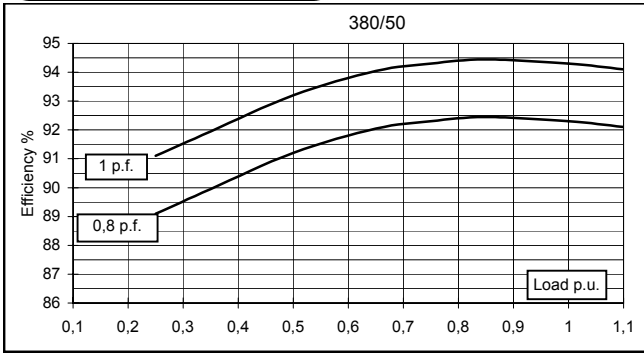



GENERATOR TYPE ECO 38-1SN/4

Document : DS070A/3

issue 004 date : 01/06/2011

60 Hz

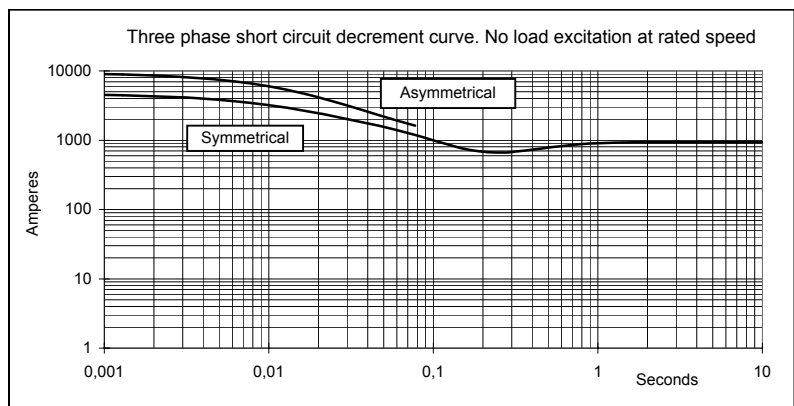
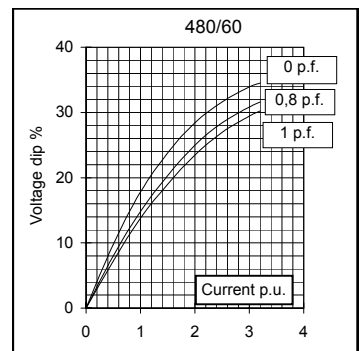
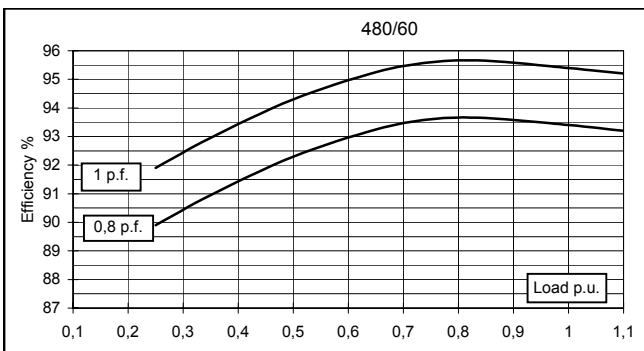
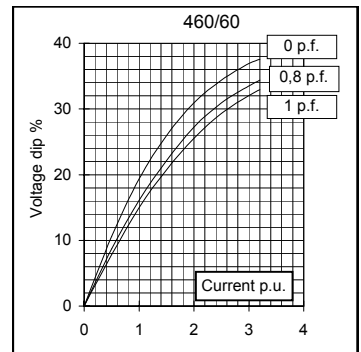
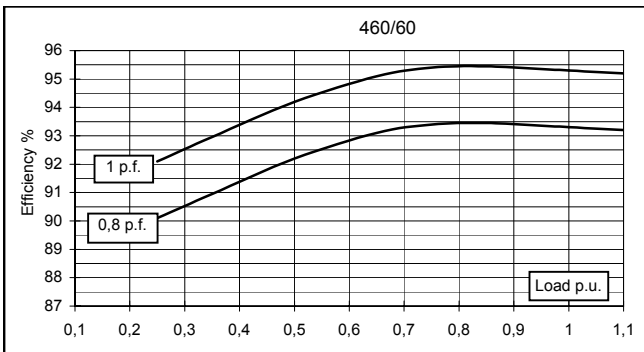
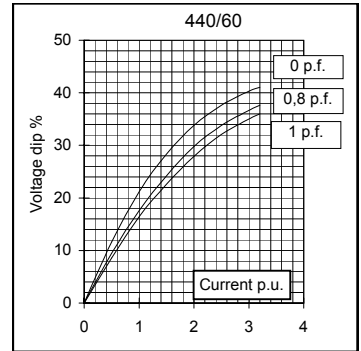
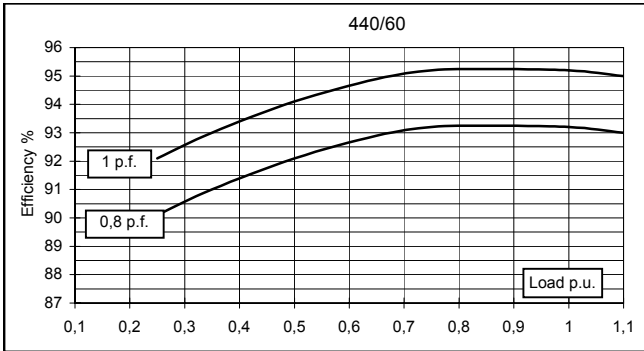
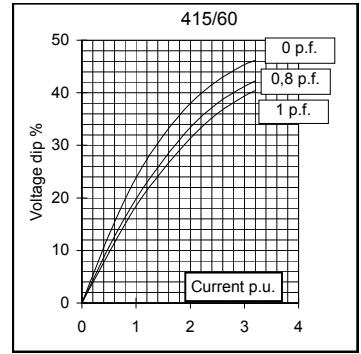
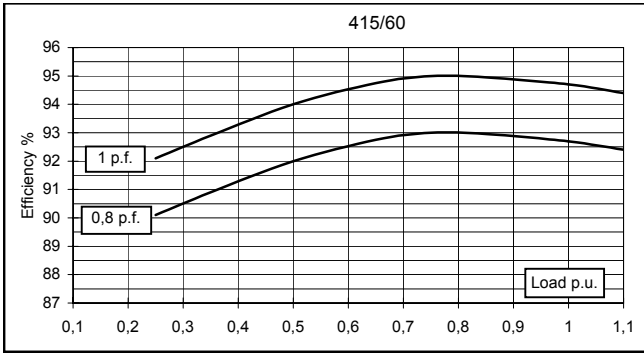

TWO BEARING MOMENTS OF INERTIA

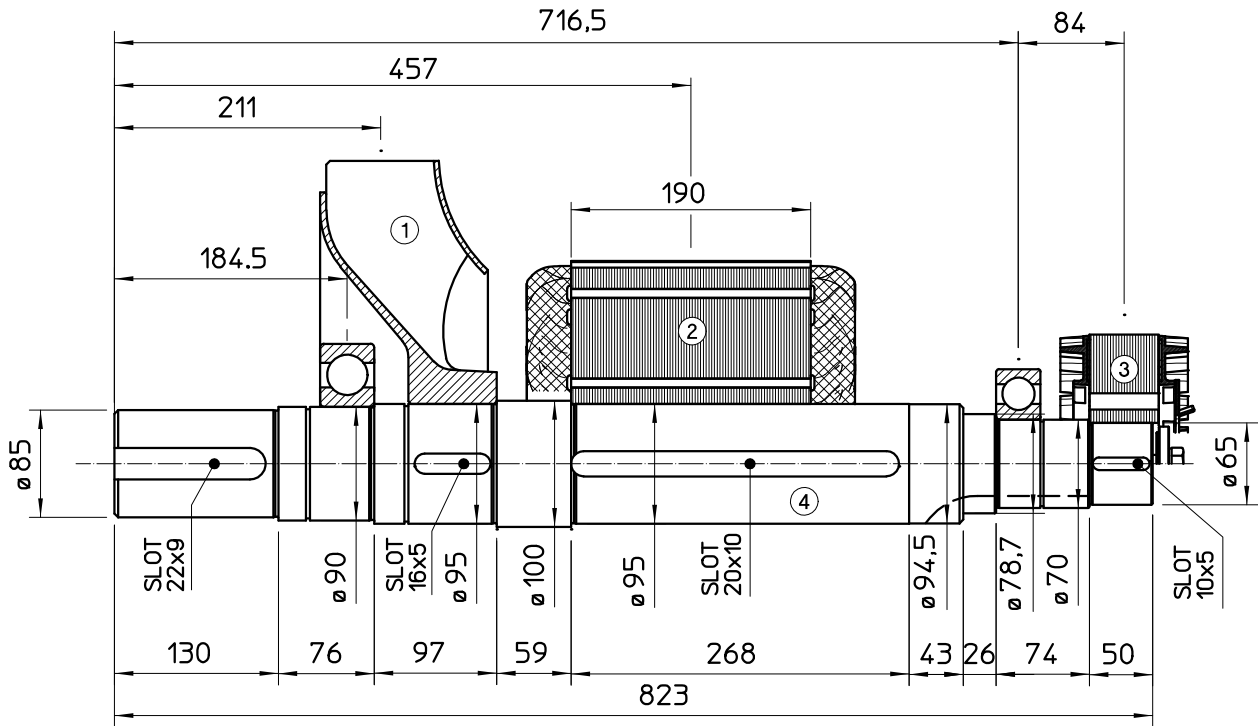

POS.	COMPONENT	WEIGHT (kg)	J (kgm ²)
1	FAN	6.1	0.1887
2	MAIN ROTOR	103	1.4085
3	EX. ROTOR	14.5	0.0874
4	SHAFT	38.5	0.0397
TOTAL		162.1	1.7243

TWO BEARING DIMENSIONS

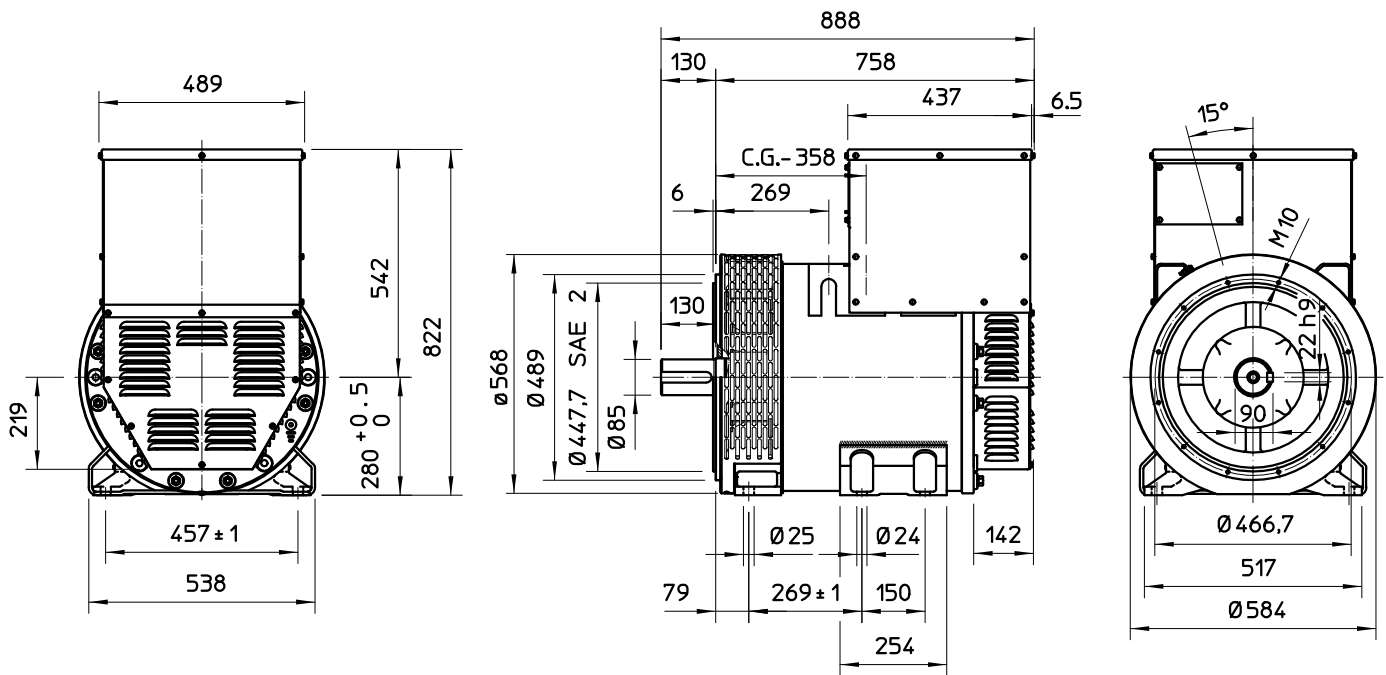

SINGLE BEARING MOMENTS OF INERTIA

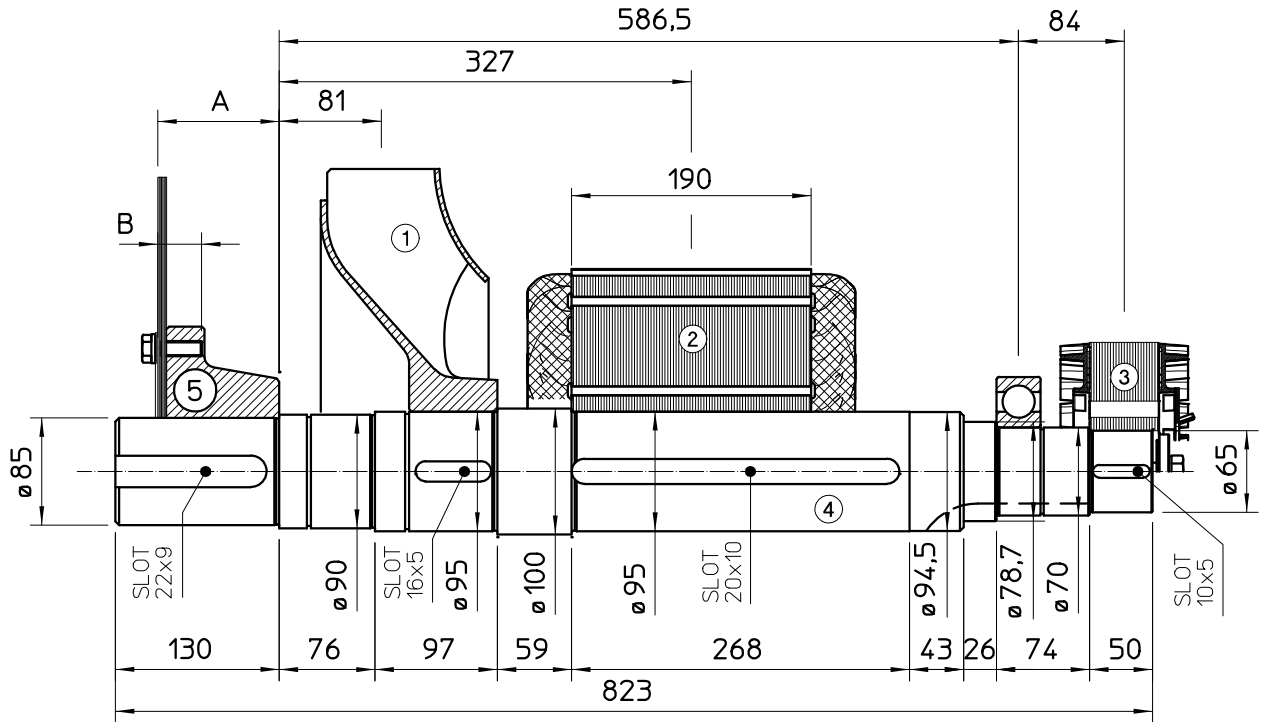

POS.	COMPONENT	WEIGHT (kg)	J (kgm ²)
1	FAN	6.1	0.1887
2	MAIN ROTOR	103	1.4085
3	EX. ROTOR	14.5	0.0874
4	SHAFT	38.5	0.0397
TOTAL		162.1	1.7243

SAE N°	SHAFTS COUPLING FLEX PLATE			
	A	B	WEIGHT kg	J kgm ²
11.5	110.4	41.1	20.5	0.174
14	96.4	34.7	23.5	0.275

SINGLE BEARING DIMENSIONS

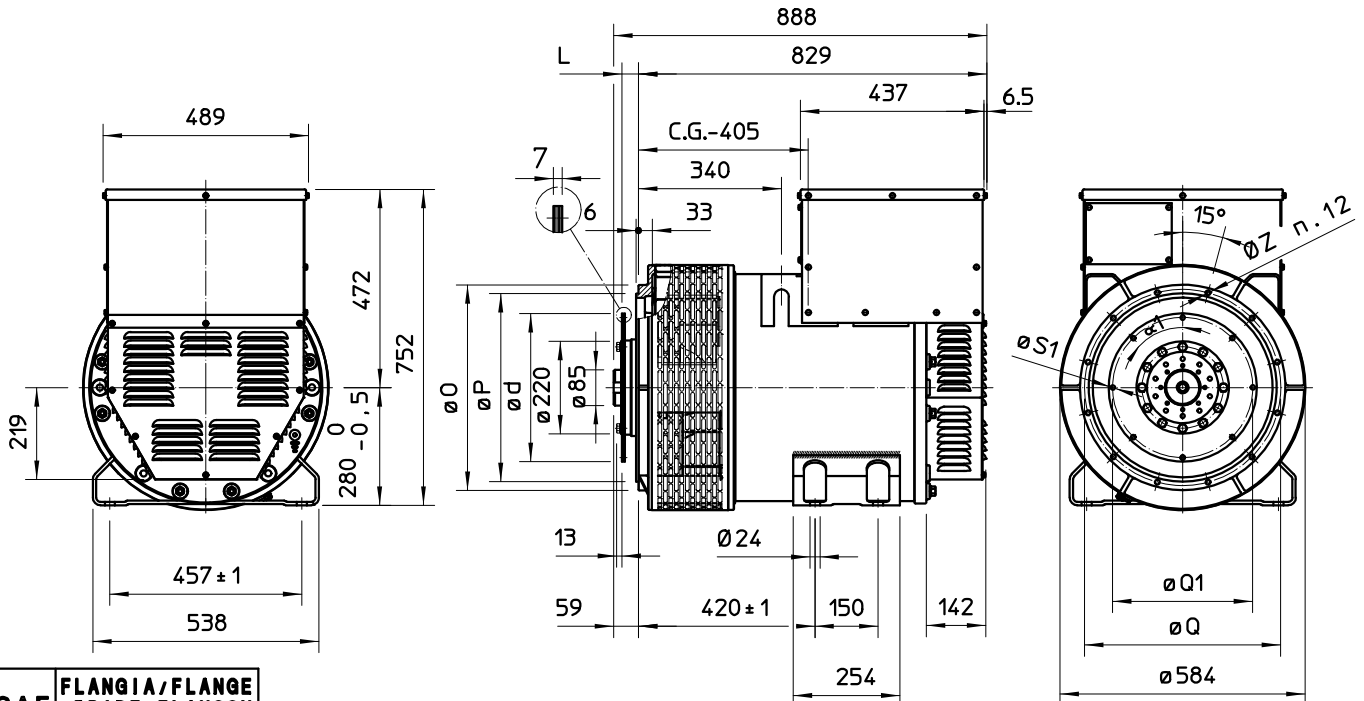

SAE N.	FLANGIA/FLANGE BRIDE/FLANSCH		
	O	P	Q
3	451	409,6	428,6
2	489	447,7	466,7
1	552	511,2	530,2
1/2	648	584,2	619,1

SAE N.	GIUNTI A DISCHI DISC COUPLING DISQUE DE MONOPALIER SCHEIBENKUPPLUNG					
	L	d	Q1	n. fori	S1	OC1
11 1/2	39,6	352,42	333,37	8	11	45°
14	25,4	466,72	438,15	8	14	45°

C.G.= GRAVITY CENTER