



GENERATOR TYPE ECO 32-2S/4

Document : **DS006A/1**

issue 007 date 25/07/2011

Electrical Characteristics										
Frequency	Hz	50				60				
Voltage (series star)	V	380	400	415	440	415	440	460	480	
Rated power class H	kVA	35	35	35	28	41	42	42	42	
	kW	28	28	28	22,4	32,8	34	33,6	33,6	
Rated power class F	kVA	33	33	33	26	39	40	40	40	
	kW	26,4	26,4	26,4	20,8	31,2	32	32	32	
Regulation with	DSR	±1 % with any power factor and speed variations between -5% +30%								
Insulation class		H								
Execution		Brushless								
Stator winding		12 ends								
Rotor		with damping cage								
Efficiencies class H	4/4	%	88,1	88,2	87,9	87,7	89,1	89,6	89,7	89,8
(see graph. for details)	3/4	%	88,3	88,6	88,5	88,2	89,6	90	90	90,2
	2/4	%	86,7	86,8	86,8	86,8	88,5	88,8	88,9	89
	1/4	%	81,7	81,5	81,3	81,2	85,1	85,3	85,4	85,5
Reactances (f. l.c.l. F)	Xd	%	277,0	250	232,3	165,3	326,5	297,5	272,2	250
	Xd'	%	16,62	15	13,94	9,92	19,59	17,85	16,33	15
	Xd''	%	11,75	10,6	9,85	7,01	13,84	12,61	11,54	10,6
	Xq	%	100,8	91	84,5	60,2	118,8	108,3	99,1	91
	Xq'	%	100,8	91	84,5	60,2	118,8	108,3	99,1	91
	Xq''	%	34,3	31	28,8	20,5	40,5	36,9	33,8	31
	X ₂	%	24,38	22	20,44	14,55	28,73	26,18	23,95	22
	X ₀	%	3,10	2,8	2,60	1,85	3,66	3,33	3,05	2,8
Short Circuit Ratio	Kcc		0,60	0,70	0,86	1,38	0,40	0,50	0,60	0,70
Time Constants	Td'	sec.	0,058							
	Td''	sec.	0,012							
	Tdo'	sec.	1,35							
	Tα	sec.	0,025							
Short Circuit Current Capacity		%	>300				>350			
Excitation at no load	Amp.		0,47	0,64	0,73	1,1	0,3	0,4	0,46	0,6
Excitation at full load	Amp.		2,1	2,2	2	2,5	1,9	1,7	1,6	1,7
Overload (long-term)	%	1 hour in a 6 hours period 110% rated load								
Overload per 20 sec.	%	300								
Stator Winding Resistance (20°C)	Ω	0,097								
Rotor Winding Resistance (20°C)	Ω	2,01								
Exciter Resistance (20 °C)	Ω	Rotor : 0,417				Stator : 10,6				
Heat dissipation at f.l.c.l.H	W	3782	3746	3854	3142	4013	3900	3858	3816	
Telephone Interference		THF < 2%				TIF > 45				
Radio interference		EN61000-6-3, EN61000-6-1. For others standards apply to factory								
Waveform Distors.(THD) at f. load	LL/LN %	4 / 3,9								
Waveform Distors.(THD) at no load	LL/LN %	3,5 / 3,4								
Mechanical characteristics										
Protection		IP 21 (other protection on request)								
DE bearing		6312-2RS								
NDE bearing		6309-2RS								
Weight of wound stator assembly	kg	56								
Weight of wound rotor assembly	kg	39,5								
Weight of complete generator	kg	199								
Maximum overspeed	rpm	2250								
Unbalanced magnetic pull at f.l.c.l.F	kN/mm	4,5								
Cooling air requirement	m³/min	11,8				14,5				
Inertia Constant (H)	sec.	0,113				0,136				
Noise level at 1m/7m	dB(A)	75 / 60				79 / 64				

All technical data are to be considered as a reference and they can be modified without notice

This document is a propriety of Mecc Alte S.p.a..All rights reserved.

50 Hz

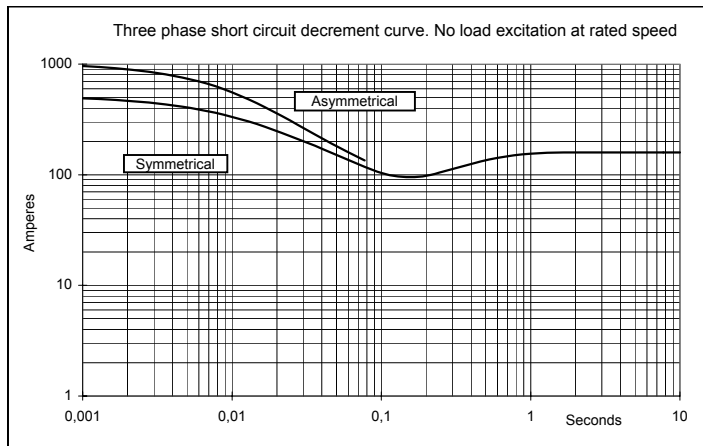
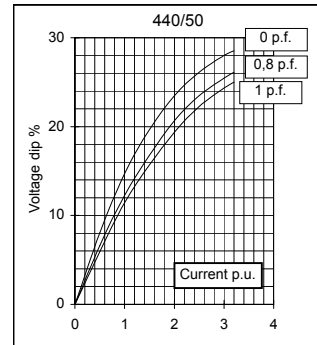
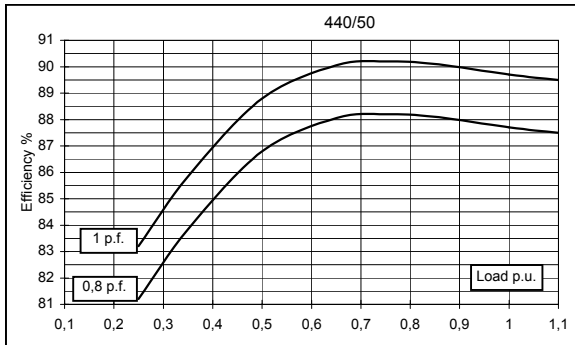
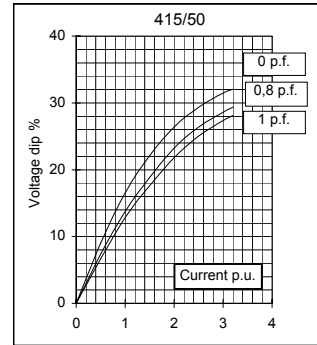
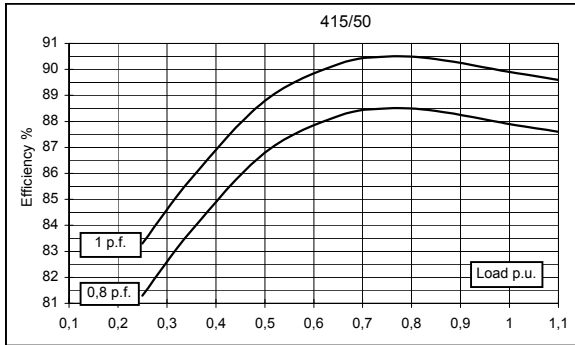
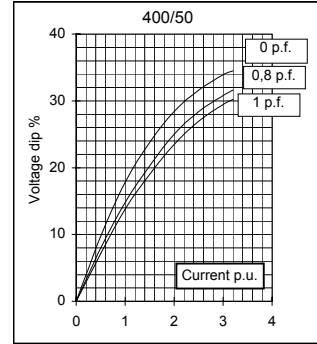
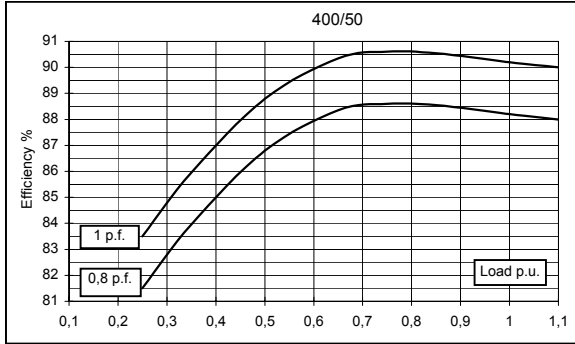
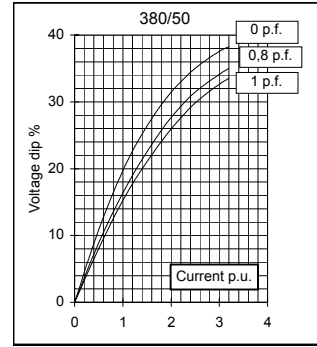
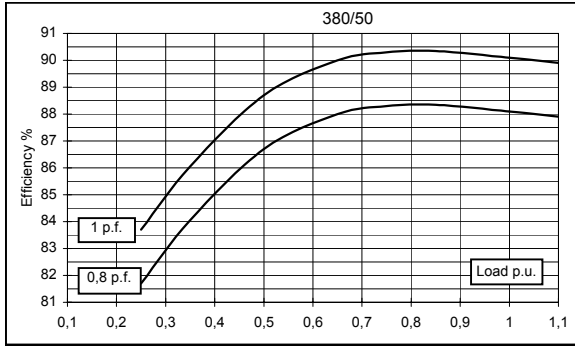

60 Hz

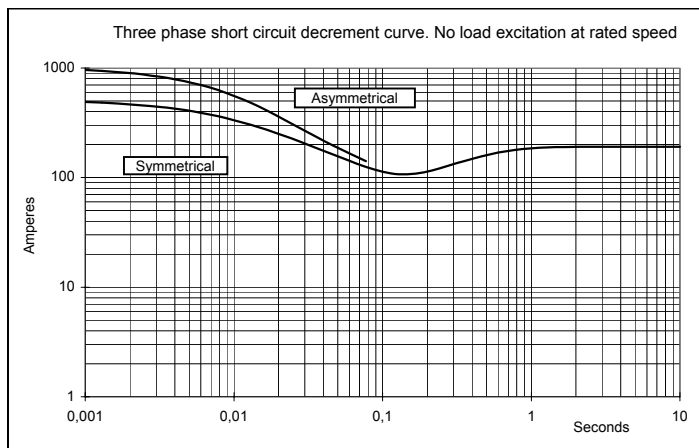
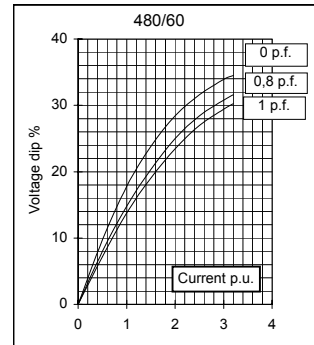
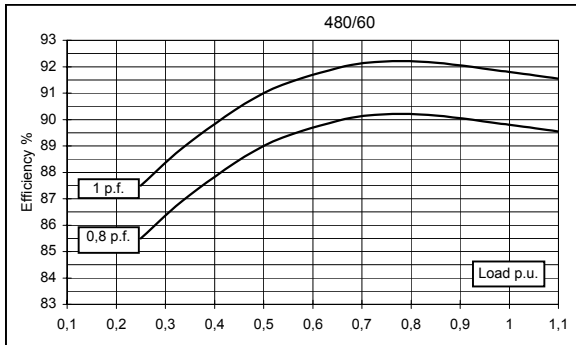
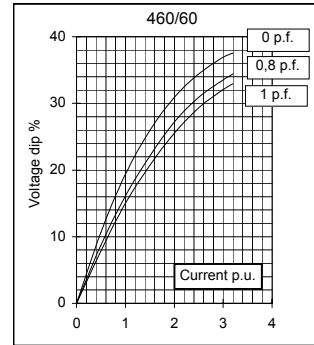
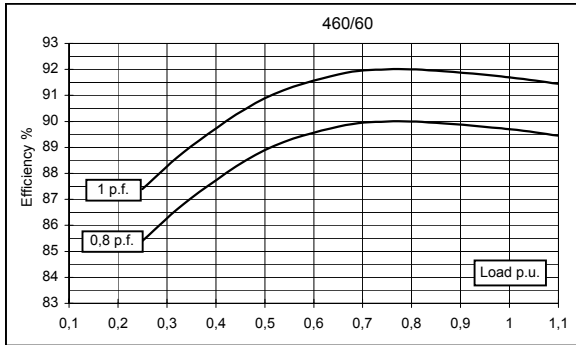
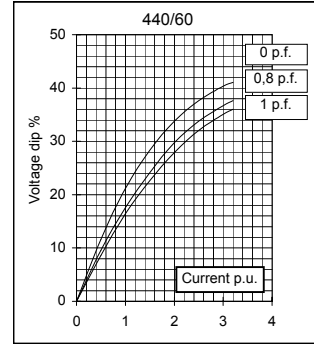
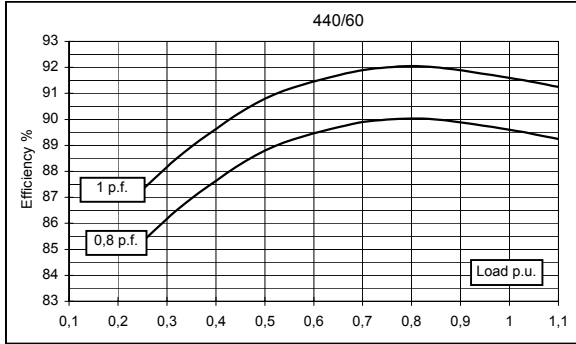
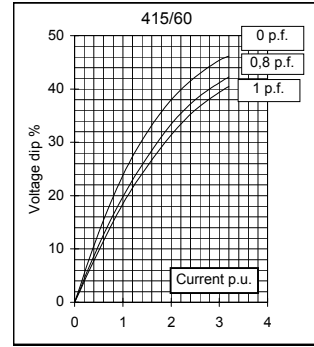
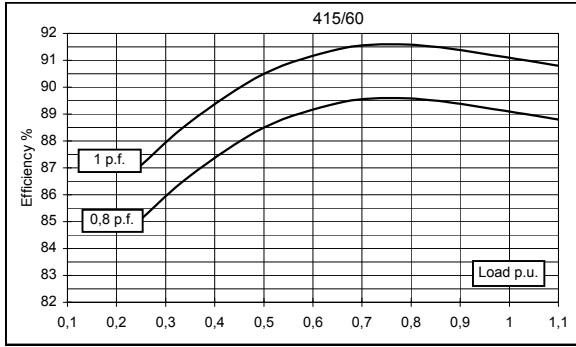

TWO BEARING MOMENTS OF INERTIA

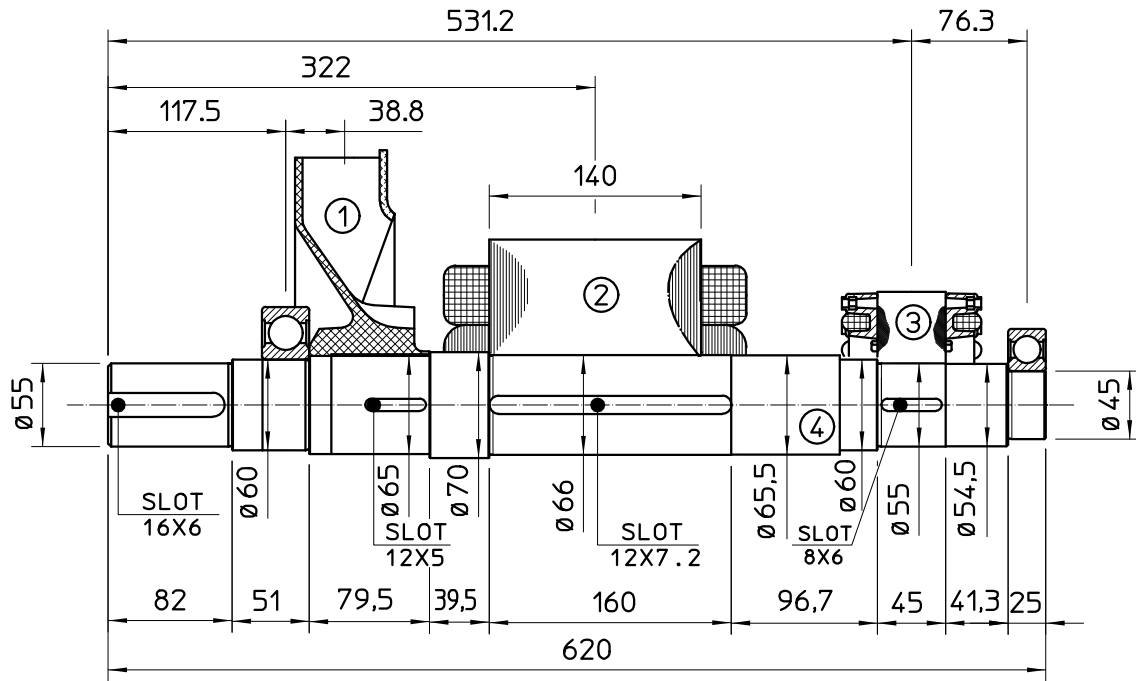

POS.	COMPONENT	WEIGHT (kg)	J (kgm ²)
1	FAN	2.3	0.0224
2	MAIN ROTOR	39.5	0.2804
3	EX. ROTOR	5.4	0.012
4	SHAFT	14.1	0.0069
TOTAL		61.3	0.3217

TWO BEARING DIMENSIONS

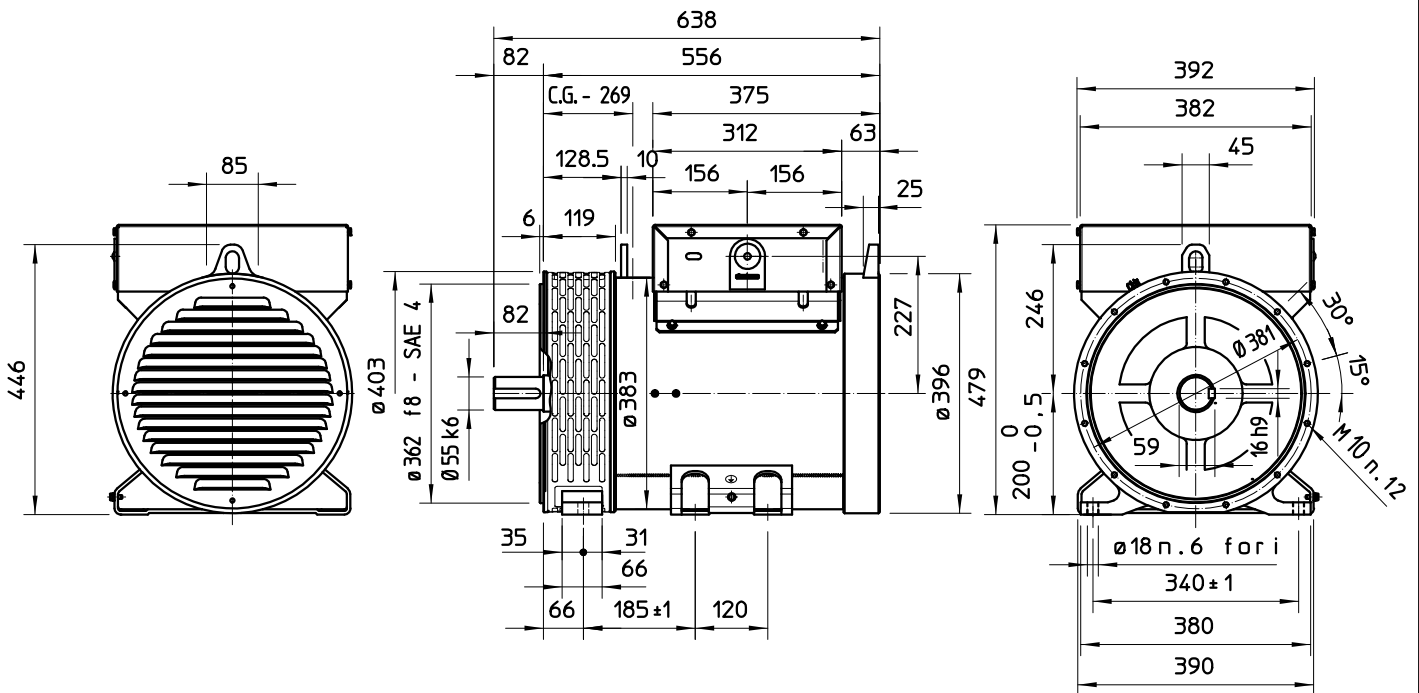

SINGLE BEARING MOMENTS OF INERTIA

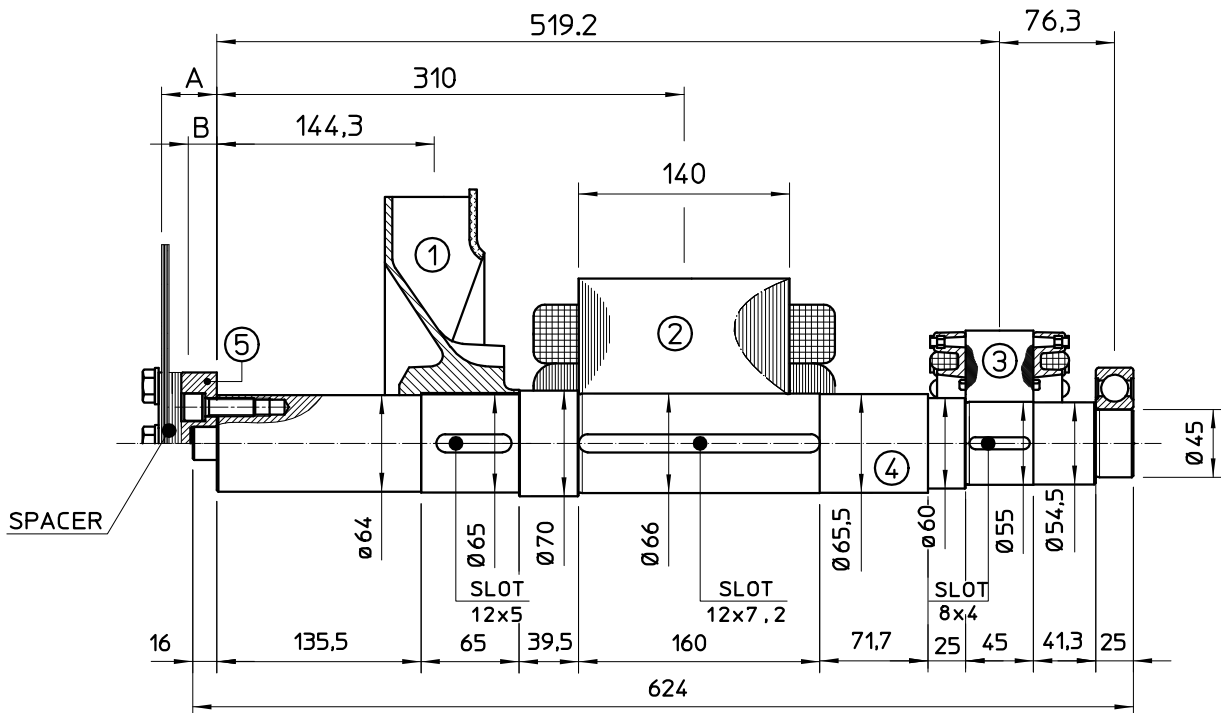

POS.	COMPONENT	WEIGHT (kg)	J (kgm ²)
1	FAN	2.3	0.0224
2	MAIN ROTOR	39.5	0.2804
3	EX. ROTOR	5.4	0.012
4	SHAFT	14.5	0.0074
TOTAL		61.7	0.3222

SAE N°	SHAFTS COUPLING FLEX PLATE			
	A	B	WEIGHT kg	J kgm ²
5	5	2.5	1.74	0.0084
6.5	5	2.5	2.1	0.013
7.5	36.6	28.1	3.9	0.02
8	28.6	21.6	4.47	0.038
10	15	11.5	4.51	0.059

SINGLE BEARING DIMENSIONS

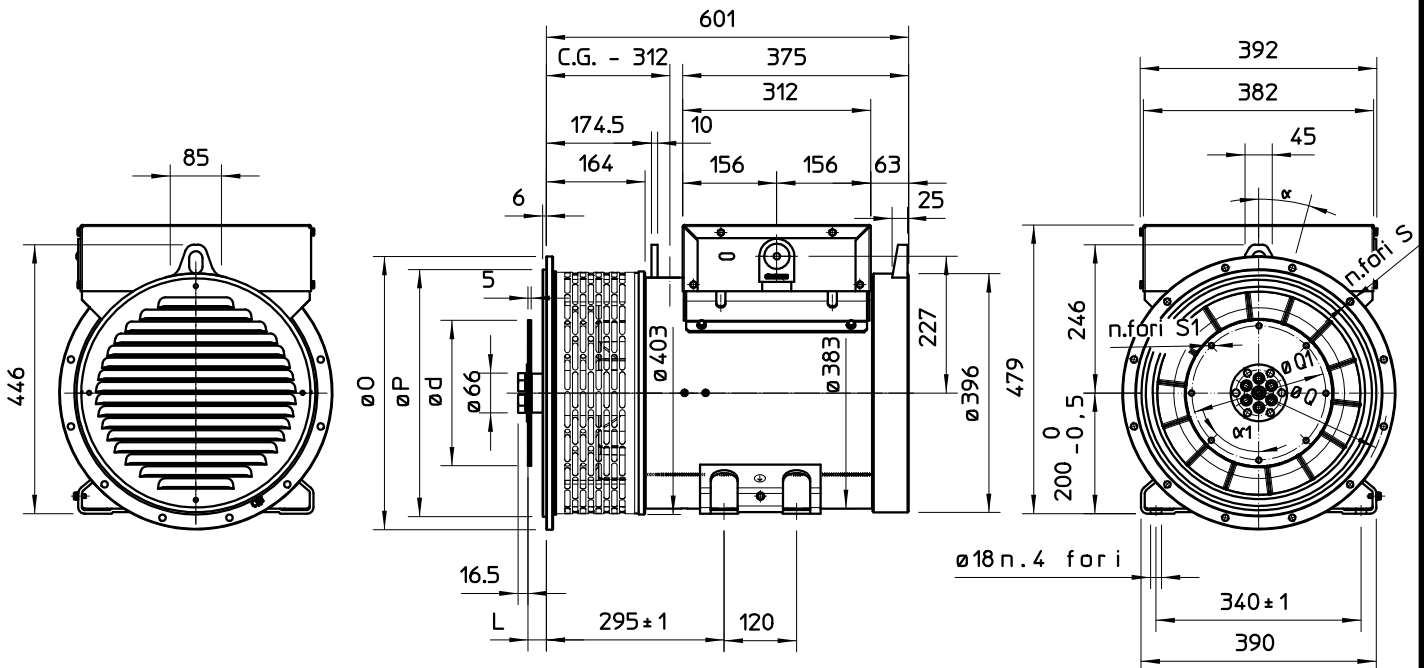

SAE N.	FLANGIA / FLANGE BRIDE / FLANSCH					
	O	P	Q	S	N. FORI HOLES N°	α
5	356	314.3	333.4	11	8	45
4	403	362	381	11	12	30
3	451	409.6	428.6	11	12	30
2	490	447.7	466.7	11	12	30
1	552	511.2	530.2	11	12	30

SAE N.	GIUNTI A DISCHI / DISC COUPLING DISCQUE DE MONOPALIER / SCHEIBENKUPPLUNG					
	d	L	Q1	S1	N. FORI HOLES N°	α1
6 1/2	215.9	30.2	200	9	6	60
7 1/2	241.3	30.2	222.25	9	8	45
8	263.52	62	244.47	11	6	60
10	314.32	53.8	295.27	11	8	45
11 1/2	352.42	39.6	333.37	11	8	45

C.G.= GRAVITY CENTER